

Determine the Impedance Value of Fault Current Limiter (FCL) in Electric Power System

Mahmoud Modaresi¹, Hamid Lesani^{2*}

¹ Department of Electrical Engineering, South Tehran Branch, Islamic Azad University, Tehran, Iran

² The School of Electrical and Computer Engineering, University of Tehran, Tehran, Iran

Abstract

In this paper, a method to compute optimum impedance of fault current limiter (FCL) is presented. The type of FCL impedance based on its resistance, inductance and capacitance has an effect on the amount of short circuit current reduction. Therefore, for an optimum result a complex parameter is selected for the FCL impedance. In addition, magnitude of short circuit current is also affected by location of FCL and the amount of system parameter. Due to the cost difference of real and imaginary components of FCL impedance, this calculation is based of sensitivity analysis, such that while minimizing the cost of impedance parts for FCL, reduction in fault current is maximized. Moreover, based on the maximum allowable current constraint and using a developed computer program, an optimum FCL impedance for a wide range of prices for real and imaginary components are computed. These analyses were applied on a 11 bus test system with using a specified single location of FCL.

Keywords: Fault Current Limiters (FCLs), Optimum Impedance, Short Circuit Fault Current, FCL impedance.

1. INTRODUCTION

The Short circuit current has always been one of the biggest problems of power systems that affects the electrical networks and corresponding equipment in power systems [1]–[9]. The basis of the procedure is reducing the short circuit level per increasing the network Thevenin impedance from the fault location. By opening the station's bus using some transformers with high impedance and adding series of reactors to the network, the network Thevenin impedance will increase and short circuit current will decrease. These kinds of methods cause network losses and also voltage drop in network's normal state and even

can endanger network stability [1]–[3], [7]–[12].

In another method, by using some equipment called fault current limiter (FCL) in fault instant, a series of impedance are added to the network to decrease the short circuit current amplitude. Impedance operation mechanism and entrance and exit time cause the difference between types of FCL. Supper conducting FCL [2]–[5], [11], [13]–[15], parallel and series of resonance FCL, [9], [10], magnetic FCL [6], [16], solid state FCL [8], [17] and hybrid FCL [18] are some of the different types of fault current limiter. FCL impedance can be resistive, inductive, capacitive or a mixture of them. One of the important problems for network designers is how to choose the type and amount of FCL impedance [6], [9], [14], [15].

*Corresponding Author's Email: lesani@ut.ac.ir

In papers [1], [4], [5] FCL impedance is considered to be a pure inductive reactance and then a cost function is represented which is consisted of the number and the sum of FCL impedance. Through a computerized algorithm, FCL impedance has been determined in such a way that cost function is the less and short circuit current of all bus bars is no more than allowable cut of power switches.

In references [2], [15], [19] super conducting resistive and inductive FCLs are used. The number and amount of FCL impedance are determined in a way that while system stability is increased, the limitation of bus short circuit current is resolved. The effect of the pure inductive and resistive impedance on decreasing of system fault current is also compared. Hence, resistive type has gain more attention.

In [20] the impedance of a pure resistive FCL is determined by taking into account the transformer irruptive current and the rate of FCL voltage drop. Also a coefficient has been determined to make these two parameters, irruptive current and FCL voltage, comparable.

The main goal of installing FCL in this paper is to reduce irruptive current and reducing the fault current of bus bar which was not considered. In the mentioned papers, FCL impedance is considered as to be only pure resistive or inductive while the impedance generally is a mixture of resistance, inductance and capacitance. Also references [11], [13], [14] showed that the fault current value is decreased in the form of a homographic function by increasing the FCL impedance. So, for big value impedance, fault current will import to the saturation region and the rate of reduction became slow. In these cases, choosing the FCL impedance based on the maximum tolerable current cannot be necessarily optimum.

In this paper, the impedance of FCL is assumed to be a complex value. Then, depending on the network configuration, a new method is proposed such that by considering the saturation effect and also construction cost for real and imaginary parts of FCL impedance, the optimum value for FCL impedance is determined at certain

location of network. The results are then verified using a computer program developed for 11-buses network. It should be mentioned that the FCL positioning is not the main goal of this paper and it can be taken into account in the future studies.

2. NETWORK MODELING AND CALCULATION OF SHORT CIRCUIT CURRENT IN THE PRESENCE OF FCL

Generally, FCL impedance is a complex number and consists of real and imaginary parts. The real part of impedance, is its resistance and always is positive but the imaginary part depending on its inductance or capacitance can be positive or negative.

During the occurrence of fault, FCL impedance can be constant or variable. In FCLs with variable impedance, like superconducting FCLs, the FCL resistance amount after fault occurrence, reaches to its maximum amount rapidly in a short time [2], [4], [11], [15]. Since in this paper only the type and amount of impedance are considered, and FCL performance mechanism is not the target of this paper, hence, according to the Fig. 1 a complex impedance is considered for modeling the FCL that pre fault occurrence will be replaced in series in the network. To calculate FCLs that have variable impedance, according to references [2], [4], [15], their maximum impedance amount is considered.

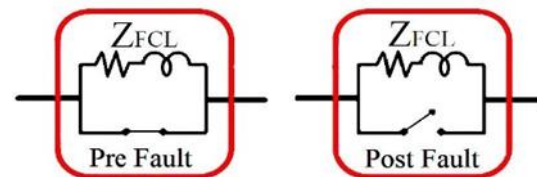

Fig. 1. Circuitual representation of the FCL at pre and post fault periods.

If we have a n-buses network and would like to place FCL between equipment A and equipment B (or combination of these equipment) and if we assume i th bus is a connection point for equipment A and B, we should first divide this bus to two parts as i_A and i_B . The place of FCL is between these two buses. This concept was shown

in Figs. 2(a), 2(b) and 2(c). In this case if the impedance matrix for n+1 bus system before FCL installation is represented by Eq. (1), then the impedance matrix after the FCL installation can be presented by Eq. (2).

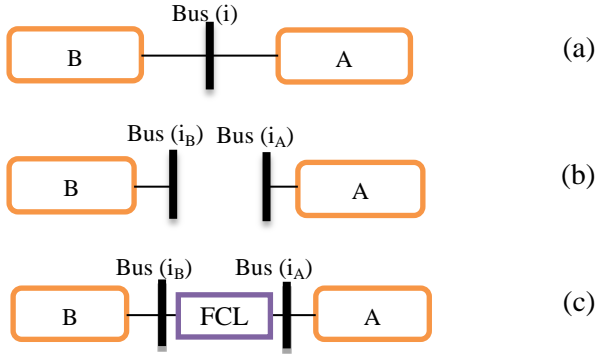

Fig 2. bus (i), (a): before installation FCL, (b): after separating, (c): after FCL installation.

$$Z_{Bus} = \begin{bmatrix} Z_{11} & \cdots & Z_{1i_A} & Z_{1i_B} & \cdots & Z_{1n} \\ \vdots & \ddots & \vdots & \vdots & \vdots & \vdots \\ Z_{i_A 1} & \cdots & Z_{i_A i_A} & Z_{i_A i_B} & \cdots & Z_{i_A n} \\ Z_{i_B 1} & \cdots & Z_{i_B i_A} & Z_{i_B i_B} & \cdots & Z_{i_B n} \\ \vdots & \vdots & \vdots & \vdots & \ddots & \vdots \\ Z_{n1} & \cdots & Z_{ni_A} & Z_{ni_B} & \cdots & Z_{nn} \end{bmatrix} \quad (1)$$

$$Z_{Bus}^{new} = \begin{bmatrix} Z_{11}^{new} & \cdots & Z_{1i_A}^{new} & Z_{1i_B}^{new} & \cdots & Z_{1n}^{new} \\ \vdots & \ddots & \vdots & \vdots & \vdots & \vdots \\ Z_{i_A 1}^{new} & \cdots & Z_{i_A i_A}^{new} & Z_{i_A i_B}^{new} & \cdots & Z_{i_A n}^{new} \\ Z_{i_B 1}^{new} & \cdots & Z_{i_B i_A}^{new} & Z_{i_B i_B}^{new} & \cdots & Z_{i_B n}^{new} \\ \vdots & \vdots & \vdots & \vdots & \ddots & \vdots \\ Z_{n1}^{new} & \cdots & Z_{ni_A}^{new} & Z_{ni_B}^{new} & \cdots & Z_{nn}^{new} \end{bmatrix} \quad (2)$$

Where:

$$Z_{jk}^{new} = Z_{jk} - \frac{(Z_{ji_A} - Z_{ji_B}) \times (Z_{i_A k} - Z_{i_B k})}{Z_{i_A i_A} + Z_{i_B i_B} - 2Z_{i_A i_B} + Z_{FCL}} \quad (3)$$

For example, Z_{ff}^{new} is Thevenin's impedance of fth bus after installing an FCL with impedance of Z_{FCL} between buses i_A and i_B is given as follow:

$$Z_{ff}^{new} = Z_{ff} - \frac{(Z_{fi_A} - Z_{fi_B}) \times (Z_{i_A f} - Z_{i_B f})}{Z_{i_A i_A} + Z_{i_B i_B} - 2Z_{i_A i_B} + Z_{FCL}} \quad (4)$$

Therefore, a general form for fault current, I_f , at bus number f, after FCL installation with impedance of Z_{FCL} between buses i_A and i_B is represented by Eq. (5). In this equation, V_f voltage of bus f, before fault occurrence is. In Eqs. (5) to (7), A, B and C are constant and function of network parameters and position of FCL and j is

$$I_f = \frac{V_f}{Z_{ff}^{new}} = A \times \frac{Z_{FCL} + B}{Z_{FCL} + D} \quad (5)$$

$$A = \frac{V_f}{Z_{ff}} = A_1 + jA_2 = |A| \angle \theta_A \quad (6)$$

$$B = Z_{i_A i_A} + Z_{i_B i_B} - 2Z_{i_A i_B} = B_1 + jB_2 \quad (7)$$

$$D = B + \frac{2Z_{fi_A} Z_{fi_B} - Z_{fi_A} Z_{i_A f} - Z_{fi_B} Z_{i_B f}}{Z_{ff}} = D_1 + jD_2 \quad (8)$$

Referring to Eq. (5), it can be seen that fault current versus FCL impedance is a homographic function. According to Eq. (9), if the FCL impedance is a complex number, the magnitude of fault current can be calculated by Eq. (10). Fig. 3 shows the variations of the fault current with respect to real and imaginary parts of FCL impedance for a test network. In this equation, R is resistive part of impedance and is always positive but X is the imaginary part of impedance and can be either positive or negative depending on inductive or capacitive properties of impedance respectively.

$$Z_{FCL} = R + jX \quad (9)$$

$$|I_f| = |A| \times \sqrt{\frac{(R + B_1)^2 + (X + B_2)^2}{(R + D_1)^2 + (X + D_2)^2}} \quad (10)$$

From Fig. 3, it can be seen that the fault current for R-L impedance is decreased as a homographic function but it first increases and then decreases for R-C impedance. When the current decrease, it first reaches to a minimum and then increases and reaches to a fixed value which is less than its initial value.

For such a system, finding an optimum value for FCL impedance is difficult and complicated,

since the objective for optimization is to maximize the fault current reduction using minimum value for FCL impedance and these two goals are contradictory to each other. In addition if for example we have to limit the fault current with resistive or induction impedance, this is impossible to obtain a minimum value for fault current and this minimum will occur at infinite value for impedance.

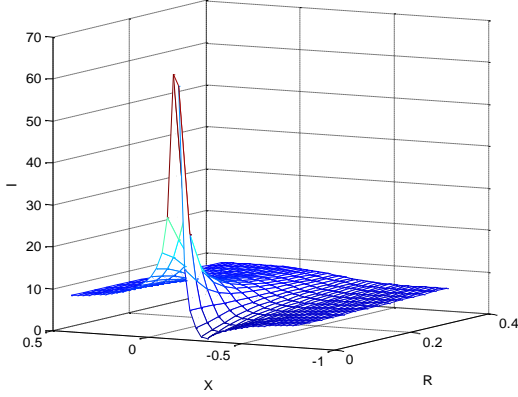

Fig 3. differentiation of fault current to FCL's impedance in an 11 bus network.

3.FCL IMPEDANCE LOCUS FOR MAXIMUM TOLERABLE CURRENT OF BUS

If basis of choosing FCL impedance was based on the maximum tolerable current of the bus (I_c), by replacing $|I_f|=I_c$ in Eq. (10), some points of X and R obtains that in those points the short circuit current equals to I_c . According to Eq. (11) by considering $M = \frac{I_c}{|A|}$ the locus would be a circle

which its center is $R = \frac{B_1 - M^2 D_1}{M^2 - 1}$,

$X = \frac{B_2 - M^2 D_2}{M^2 - 1}$ and its radius is

$$\frac{M \sqrt{(D_1 - B_1)^2 + (D_2 - B_2)^2}}{M^2 - 1} \quad (11)$$

$$\left[R + \left(\frac{M^2 D_1 - B_1}{M^2 - 1} \right) \right]^2 + \left[X + \left(\frac{M^2 D_2 - B_2}{M^2 - 1} \right) \right]^2 = \left[\frac{M \sqrt{(D_1 - B_1)^2 + (D_2 - B_2)^2}}{M^2 - 1} \right]^2$$

If M was a number bigger than one, the locus of X and R that may be the answer of the problem, are located out of the circle and if M was a number less than one this locus would contain the answers in the circle. It should be considered that resistance is a positive number, so negative an-

swers whether in or out of the circle are not considered as the answers.

Since the target of limiting the fault current is to reduce FCL impedance, so depending on the location of circle center, the amount of one of the resistive, inductive or capacitive impedance is the best. For example, if the circle in Fig. 4 was the locus of some R and X points that fix the problem's terms, so choosing inductive impedance in comparison to other impedances would have fewer amounts, so in this view is the best.

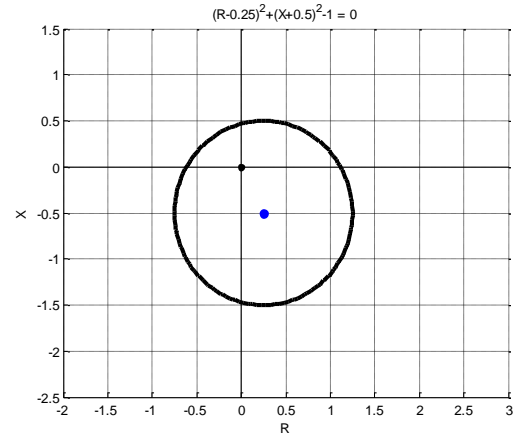

Fig 4. FCL impedance locus to fix the short circuit current constraints of a sample bus

Studies on different network shows that choosing FCL impedance based on reducing the current to I_c doesn't necessarily lead to the best answer. Since FCL impedance complex structure, construction cost of real and imaginary parts may be different. The cost difference also can strongly affect the process of choosing the optimum impedance. So that according to Fig. 3, for example, if the cost of a resistive FCL was a third of the cost of inductive FCL, choosing the resistive FCL would be more favorable in spite of bigger impedance amount.

Also in some cases, it's possible to reduce the short circuit current significantly by spending less money and increasing FCL impedance. According to references [5]–[8], [21]–[24], the less short circuit current, the less mechanical stresses on the equipment. This can cause equipment fault rate reduction and system's reliability growth. So, the more short circuit current, especially when spending less cost cause this reduction, the

more desirable option. So, a new way has been represented that the rate of short circuit current reduction ratio the cost which is need for this current reduction is examined.

4.OPTIMIZATION THE FCL IMPEDANCE VALUE

The reason for selection of optimum and more efficient value for FCL impedance is due to this fact that high value for this impedance will increase the cost of FCL construction [1], [4], [5].

The proposed method in this paper is using sensitivity analysis which is a complex method as due to complex nature of impedance; we should implement two dimension sensitivity analyses which will be discussed in the next section. From Eq. (9), the magnitude ($|Z|$) and phase (Θ) of FCL impedance can be expressed by Eqs. (12) and (13) as follows:

$$|Z| = \sqrt{R^2 + X^2} \quad (12)$$

$$\theta = \tan\left(\frac{X}{R}\right) \rightarrow -90 \leq \theta \leq 90 \quad (13)$$

So R and X can be expressed by Eqs.(14) and (15) as follows:

$$R = |Z| \cos \theta \quad (14)$$

$$X = |Z| \sin \theta \quad (15)$$

Based on this analysis if $\Theta = -90$, the FCL impedance is pure capacitive, while for $\Theta = 90$ and $\Theta = 0$, the FCL impedance is pure inductive and resistive respectively. For $-90^\circ \leq \theta \leq 0^\circ$, the impedance is combination of resistor and capacitor and for $0^\circ \leq \theta \leq 90^\circ$, the impedance is combination of resistor and inductor.

The cost of FCL is calculated based of each element used in its impedance (resistor, capacitor or inductor). For example the FCL cost is the cost of resistor plus the cost of its imaginary part which can be inductor or capacitor. Since the cost

for real part and imaginary part may be different, we define two parameters as β and γ . Based on this definition, β and γ are 1 Ohm inductor to 1 Ohm resistor costs and 1 Ohm capacitor to 1 Ohm resistor costs ratios respectively.

Also if the network designers prefer to use of one of resistive, inductive or capacitive impedance, depending to design priority and not because of cost, chooses proper β or γ . For example if from the designer point of view, he thinks that, inductor impedance to resistor impedance has a preference rate of 2 and inductor impedance to capacitor impedance has a preference ratio of 8, so he/she chooses $\beta = 0.5$ and $\gamma = 4$.

According to Eq. (16), the new variable Z' consists of real and imaginary part of FCL impedance.

$$Z' = \begin{cases} R + \beta X, & \text{if } X \text{ is positive} \\ R - \gamma X, & \text{if } X \text{ is negative} \end{cases} \quad (16)$$

Using Eqs. (14), (15) and (16), this parameter can be also expressed by Eq. (17). If X is positive, which means that X is an inductive reactance and If X is negative, it means that X is a capacitive reactance.

$$Z' = \begin{cases} |Z| \times (\cos \theta + \beta \sin \theta), & 0^\circ \leq \theta \leq 90^\circ \\ |Z| \times (\cos \theta - \gamma \sin \theta), & -90^\circ \leq \theta \leq 0^\circ \end{cases} \quad (17)$$

Assuming α is according to Eq. (18), R and X are according to Eq. (19) and (20) respectively.

$$\alpha = \begin{cases} (\cos \theta + \beta \sin \theta), & 0^\circ \leq \theta \leq 90^\circ \\ (\cos \theta - \gamma \sin \theta), & -90^\circ \leq \theta \leq 0^\circ \end{cases} \quad (18)$$

$$R = \frac{Z' \cos \theta}{\alpha} \quad (19)$$

$$X = \frac{Z' \sin \theta}{\alpha} \quad (20)$$

Substituting R and X into Eq. (10), one can write by Eq. (21).

$$|I_f| = |A| \sqrt{\frac{Z'^2 + 2\alpha Z'(B_1 \cos \theta + B_2 \sin \theta) + \alpha^2(B_1^2 + B_2^2)}{Z'^2 + 2\alpha Z'(D_1 \cos \theta + D_2 \sin \theta) + \alpha^2(D_1^2 + D_2^2)}} \quad (21)$$

Assuming Θ is constant; the sensitivity of fault current magnitude with respect to Z' which is defined by Eq. (22) can be expressed by Eq.

$$S = \frac{d|I_f|}{dZ'} \times \frac{Z'}{|I_f|} \quad (22)$$

$$S = \frac{Z'^2 + \alpha Z'(B_1 \cos \theta + B_2 \sin \theta)}{Z'^2 + 2\alpha Z'(B_1 \cos \theta + B_2 \sin \theta) + \alpha^2(B_1^2 + B_2^2)} - \frac{Z'^2 + \alpha Z'(D_1 \cos \theta + D_2 \sin \theta)}{Z'^2 + 2\alpha Z'(D_1 \cos \theta + D_2 \sin \theta) + \alpha^2(D_1^2 + D_2^2)} \quad (23)$$

By equating the derivative of S with respect to Z' equal to zero, one can calculate the extreme points of the sensitivity. In addition at the points in which the sensitivity is zero, the fault amplitude curve has minimum and maximum which can be the solution to our problem. Therefore by using a computer algorithm and doing some mathematical calculations and assuming that Θ varies for -90 to $+90$ degrees, one can first find candidates for optimum FCL impedance. Then from the obtained solutions and by comparing the fault current variations to Z' ratio, we can choose the optimum solution.

5. THE TEST RESULT OVER 11-BUSES NETWORK

The 11-buses power system network for a power company whose parameters are recorded at Tables I to IV are shown in Fig. 5. The fault currents are calculated for all buses and the limit these current a FCL which is shown in Fig. 6 is suggested. Considering the fault current for 10th bus is maximum, optimum impedance for FCL should be calculated for bus 10. The coefficient A , B and D from the bus 10 point of view in the presence of FCL are calculated according to Eqs. (6) to (8), and recorded at Table V.

(23). In this equation S is the sensitivity of fault current magnitude with respect to Z' when Θ is constant.

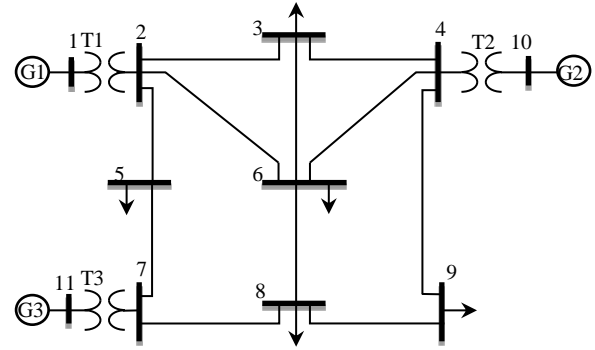

Fig 5. The 11 bus network before FCL installed.

Table 1. generator's transient impedance in pu

X'd	Ra	Number G
0.2	0	1
0.15	0	10
0.25	0	11

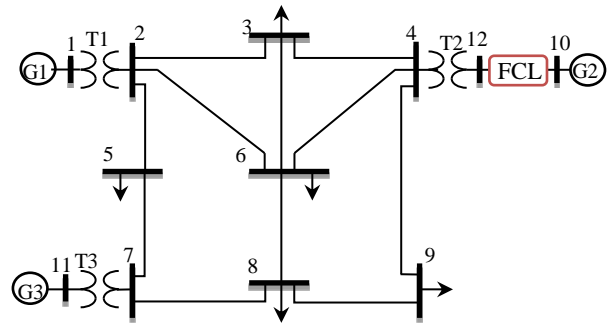

Fig 6. The 11 bus network after FCL installed.

Table 2. lines and transformer data

1/2BL, pu	XL, pu	RL, pu	To Bus Number	From Bus Number
0	0.06	0	2	1
0.0004	0.30	0.08	3	2
0.0002	0.15	0.04	5	2
0.0005	0.45	0.12	6	2
0.0005	0.40	0.10	4	3
0.0005	0.40	0.04	6	3
0.0008	0.60	0.15	6	4
0.0009	0.70	0.18	9	4
0	0.08	0	10	4
0.0003	0.43	0.05	7	5
0	0.48	0.06	8	6
0.0004	0.35	0.06	8	7
0	0.10	0	11	7
0	0.48	0.025	9	8

Table 3. Load data

Load MVar	Load MW	Number
0	0	1
0	0	2
120	150	3
0	0	4
60	120	5
90	140	6
0	0	7
90	110	8
50	80	9
0	0	10
0	0	11

Table 4. Generator data

MVar Limits Min	MVar Limits Max	Generation	Vpu	Number
180.0			1.040	1
120.0	0	200.0	1.035	10
120.0	0	160.0	1.030	11
120.0	0	160.0	1.030	11

Table 4. A, B and D parameter for fcl from the bus 10 point of view

FCL is between G2 and T2	
6.9	A
0.0077653	B1
0.30648	B2
0.0077653	D1
0.15648	D2

The fault current and its sensitivity with respect to Z' for bus number 10 are depicted in Figs. 7 to 14. The value for β and γ are assumed to be unity which means all resistive, inductive and capacitive impedances have equal cost per Ohm. The various values for θ shown in the figures represent the impedance type for FCL (Capacitive, inductive and resistive).

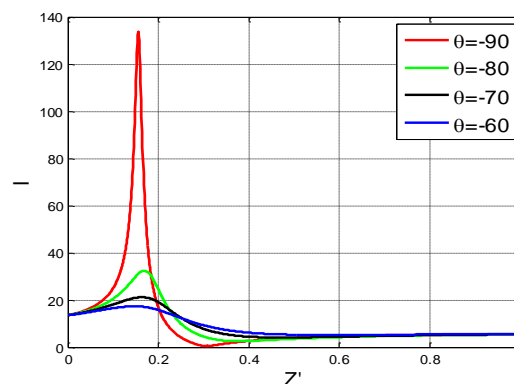

Fig.7. Alterations of fault current to Z' for $-90^\circ \leq \theta \leq 60^\circ$

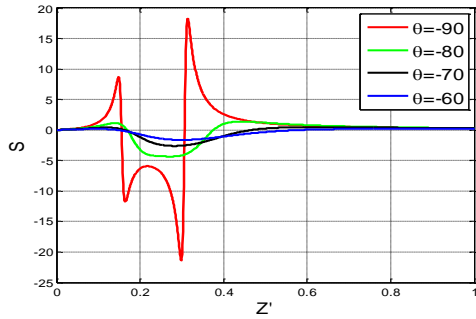

Fig 8. Alterations of S sensitivity to Z' for $-90^\circ \leq \theta \leq 60^\circ$

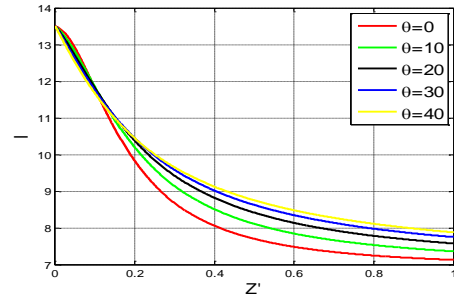

Fig 11. Alterations of fault current to Z' for $0^\circ \leq \theta \leq 40^\circ$

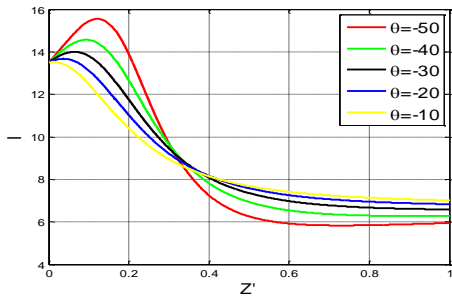

Fig 9. Alterations of fault current to Z' for $-50^\circ \leq \theta \leq -10^\circ$

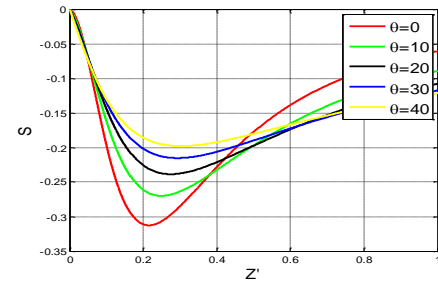

Fig 12. Alterations of S sensitivity to Z' for $0^\circ \leq \theta \leq 40^\circ$

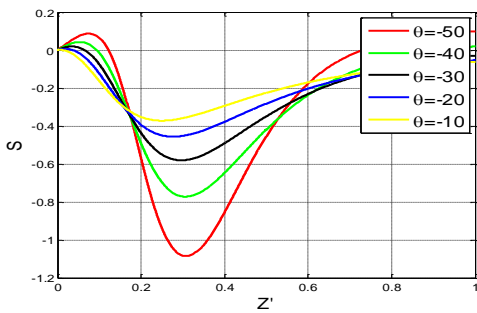

Fig 10. Alterations of S sensitivity to Z' for $-50^\circ \leq \theta \leq -10^\circ$

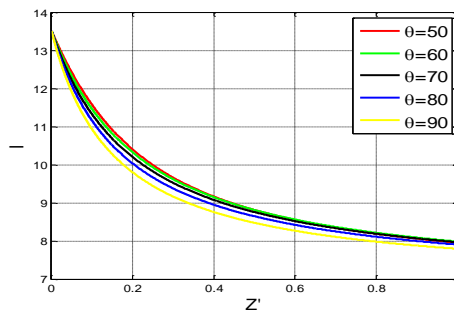

Fig 13. Alterations of fault current to Z' for $50^\circ \leq \theta \leq 90^\circ$

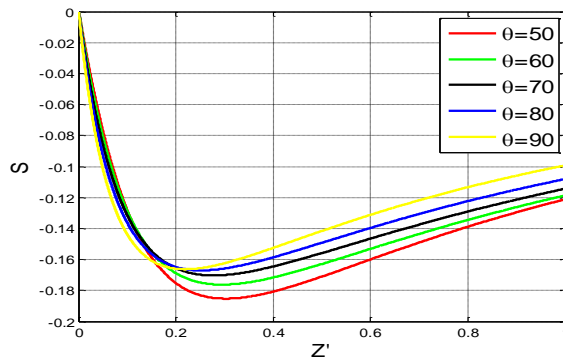

Fig 14. Alterations of S sensitivity to Z' for $50^\circ \leq \theta \leq 90^\circ$

The results show that FCL with any impedance type such as pure inductive, pure resistive and pure capacitive or even their combinations can have an optimum solution, however as the network is inductive, the sensitivity of fault current for capacitive FCL is much higher than that of resistive and inductive. Therefore, using a capacitive FCL with proper impedance, the fault current can be significantly reduced to a desirable value. Since the fault current for R-C impedances is first increased with increasing Z' and then reduced, we can conclude that the sensitivity curve for these impedances has few extreme points. However for R-L impedances, the fault current curve will decrease with increasing Z' and therefore the sensitivity has only one optimum point.

Based on the analysis performed in the proposed method, the optimum impedance of FCL for $-90^\circ \leq \theta \leq 90^\circ$, $0 \leq \beta \leq 2$ and $0 \leq \gamma \leq 4.5$ have been calculated and shown in Figs. 15 to 20.

In Fig. 15 the values Θ for various values of β and γ are -90 , 0 and $+90$ degrees. It means that depending on these values of β and γ , the FCL impedance can be pure capacitive, pure resistive or pure inductive. This is an interesting conclusion that for this network, using R-L or R-C impedance for FCL has no superiority over pure resistive, pure capacitive or pure inductive impedance. For example, if one uses R-C impedance for FCL, the fault current reduction to Z' ratio is less than that of pure capacitive impedance. Also if a R-L impedance is used for FCL, the fault current reduction to Z' ratio is less than that of pure inductive or pure resistive impedances. Therefore, using FCL with R-L or R-C impedances for this network is not recommended.

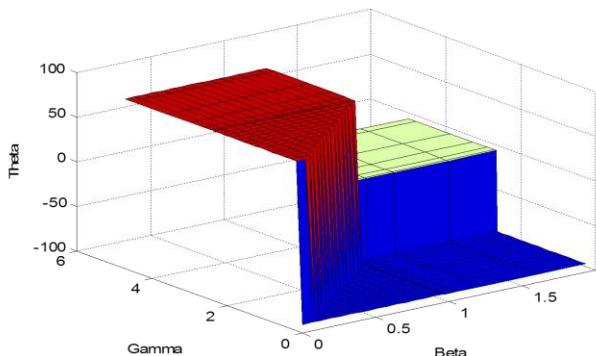

Fig 15. angle Θ for different value of β and γ for FCL

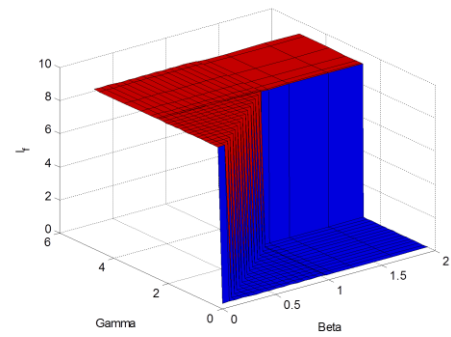

Fig16. fault current for different value of β and γ for FCL

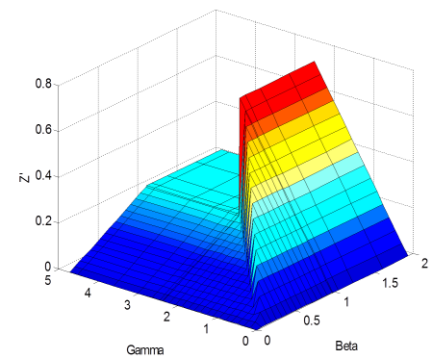

Fig 17. changes in Z' for different value of β and γ for FCL

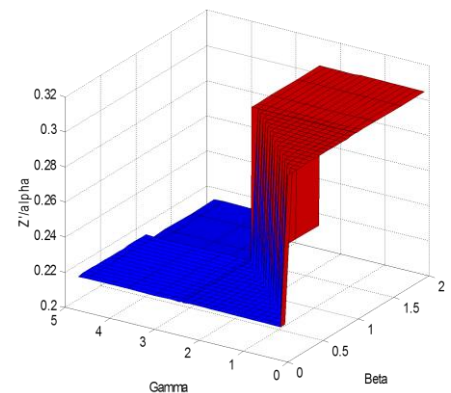

Fig 18. changes in Z'/α for different value of β and γ for FCL

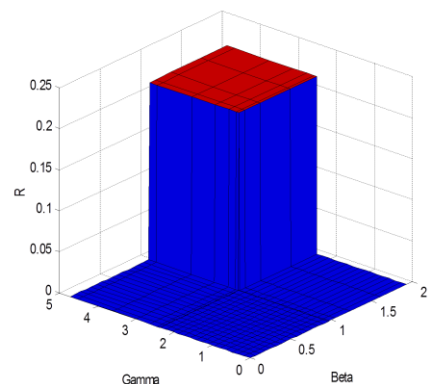

Fig19. R for different value of β and γ for FCL

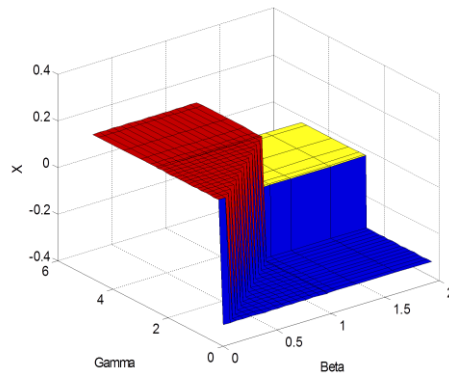

Fig 20. X for different value of β and γ for FCL

Table 6. optimized impedance value of FCL and fault current before and after installing FCL.

Kind of Impedance	FCL		
	Resistive	Inductive	Capacitive
Beta & Gamma	$\beta > 0.9651$ & $\gamma > 2.3613$	$\beta < 0.9651$ & $\gamma > (2.36 * \beta) / 0.96$	$\beta > (0.96 * \gamma) / 2.36$ & $\gamma < 2.36$
ZFCL	0.2157	i0.2194	-i0.3069
ISC without FCL		13.5018	
ISC with FCL	9.594	9.652	0.3563
Reducing current per cent	28.94	28.51	97.36
Reducing current per value of impedance	18.11	17.54	42.83

There is an important point shown in Figs. 17 and 18, this is the variation of Z' with respect to β and γ . As can be seen from these figures, although Z' changes with β and γ but as the Z' to α ratio for various values of β and γ is constant, the real part of impedance in each FCL type is unchanged with variations of β and γ . Therefore changing β and γ can only affect on selecting FCL type and has no effect on optimum impedance value of FCL and fault current.

The magnitude of FCL impedance for various ranges of β and γ and also fault current for bus-10 before and after the FCL installation are recorded in Table VI.

6. CONCLUSION

In this paper, the importance of finding an optimum value for FCL impedance in a power network has been pointed out. Since the fault current versus FCL impedance is a homographic function (fault current decrease with increasing FCL impedance), therefore to have significant reduction in fault current, the FCL impedance should be

considerably increased which in turn has direct effect on FCL equipment. Hence, selecting the FCL impedance value based on desire fault current reduction is not an optimum solution. In this paper analysis of sensitivity in term of real and imaginary parts of FCL impedance taking into account the cost of real and imaginary parts of FCL impedance was proposed and an optimum value for FCL impedance has been calculated for 11-buses network. The obtained results showed that R-L or R-C impedance have no superiority over pure resistive, capacitive or inductive impedances for most power networks. Therefore the optimum choice is possible if inductive, resistive or capacitive impedance are individually considered for FCL. However since the network is inductive, choice of capacitive impedance for FCL is an optimum choice. In other hand taking into account the different in impedance costs, we defined a new parameters β and γ and the optimum impedance was obtained by changing these parameters.

As (Z'/α) for various values of β and γ is a constant value, therefore the real part of impedance is constant in all FCL impedances and the variations of β and γ has only effect on FCL type selection and has no influence on the optimum value of impedance and also fault current of the selected FCL. This is a significant achievement obtained by our proposed method. It is worth to mention that for some power network, the choice of R-C or R-L impedance for FCL may be an optimum choice which can be a potential subject for future researches.

REFERENCES

- [1] J.-H. Teng and C.-N. Lu, "Optimum fault current limiter placement with search space reduction technique," *IET Generation, Transmission & Distribution*, vol. 4, no. 4, p. 485, 2010.
- [2] S. Alaraifi, M. S. El Moursi, and H. H. Zeineldin, "Optimal allocation of HTS-FCL for power system security and stability enhancement," *IEEE Trans. Power Syst.*, vol. 28, no. 4, pp. 4702–4711, Nov. 2013.
- [3] L. Kovalsky, X. Yuan, K. Tekletsadik, a. Keri, J. Bock, and F. Breuer, "Applications of Superconducting Fault Current Limiters in Electric Power Transmission Systems," *IEEE Trans. Applied Supercond.*, vol. 15, no. 2, pp. 2130–2133, Jun. 2005.
- [4] M. Nagata, K. Tanaka, and H. Taniguchi, "FCL location selection in large scale power system," in *IEEE Transactions on Applied Superconductivity*, 2001, vol. 11, no. 1, pp. 2489–2494.
- [5] K. Hongesombut, Y. Mitani, and K. Tsuji, "Optimal location assignment and design of superconducting fault current limiters applied to loop power systems," *IEEE Trans. Appl. Supercond.*, vol. 13, no. 2, pp. 1828–1831, Jun. 2003.
- [6] D. Cvoric, S. W. H. de Haan, J. A. Ferreira, Z. Yuan, M. van Riet, and J. Bozelie, "New Three-Phase Inductive FCL With Common Core and Trifilar Windings," *IEEE Trans. Power Deliv.*, vol. 25, no. 4, pp. 2246–2254, Oct. 2010.
- [7] M. Fotuhi-Firuzabad, F. Aminifar, and I. Rahmati, "Reliability Study of HV Substations Equipped With the Fault Current Limiter," *IEEE Trans. Power Deliv.*, vol. 27, no. 2, pp. 610–617, Apr. 2012.
- [8] A. Abramovitz and K. Ma Smedley, "Survey of solid-state fault current limiters," *IEEE Trans. Power Electron.*, vol. 27, no. 6, pp. 2770–2782, Jun. 2012.
- [9] H. Javadi, "Fault current limiter using a series impedance combined with bus sectionalizing circuit breaker," *Int. J. Electr. Power Energy Syst.*, vol. 33, no. 3, pp. 731–736, Mar. 2011.
- [10] S. B. Naderi, M. Jafari, and M. Tarafdar Hagh, "Parallel-resonance-type fault current limiter," *IEEE Trans. Ind. Electron.*, vol. 60, no. 7, pp. 2538–2546, Jul. 2013.
- [11] M. S. El Moursi and R. Hegazy, "Novel technique for reducing the high fault currents and enhancing the security of ADWEA power system," *IEEE Trans. Power Syst.*, vol. 28, no. 1, pp. 140–148, Feb. 2013.
- [12] S. M. Modaresi and H. Lesani, "Analysis of the Effect of Location and Failure Rates of Fault Current Limiters on Substations Reliability," *Int. Trans. Electr. Energy Syst.*, 2017.
- [13] M. Stemmler *et al.*, "Analysis of Unsymmetrical Faults in High Voltage Power Systems With Superconducting Fault Current Limiters," *IEEE Trans. Appl. Supercond.*, vol. 17, no. 2, pp. 2347–2350, Jun. 2007.
- [14] H. Yamaguchi and T. Kataoka, "Current Limiting Characteristics of Transformer Type Superconducting Fault Current Limiter With Shunt Impedance," *IEEE Trans. Appl. Supercond.*, vol. 17, no. 2, pp. 1919–1922, Jun. 2007.

- [15] G. Didier and J. L  v  que, "Influence of fault type on the optimal location of superconducting fault current limiter in electrical power grid," *Int. J. Electr. Power Energy Syst.*, vol. 56, pp. 279–285, Mar. 2014.
- [16] S. C. Mukhopadhyay, M. Iwahara, S. Yamada, and F. P. Dawson, "Investigation of the performances of a permanent magnet biased fault current limiting reactor with a steel core," *IEEE Trans. Magn.*, vol. 34, no. 4, pp. 2150–2152, Jul. 1998.
- [17] S. A. A. Shahriari, A. Y. Varjani, and M. R. Haghifam, "Cost reduction of distribution network protection in presence of distributed generation using optimized fault current limiter allocation," *Int. J. Electr. Power Energy Syst.*, vol. 43, no. 1, pp. 1453–1459, Dec. 2012.
- [18] C. a. Baldan, C. Y. Shigue, L. C. Guedes, A. a. Bernardes, and E. Ruppert, "Recovery Tests of an Hybrid Current Limiter Composed of a SFCL in Parallel to an Air-Core Power Reactor," *J. Supercond. Nov. Magn.*, vol. 28, no. 2, pp. 691–695, Feb. 2015.
- [19] G. Didier, C. H. Bonnard, T. Lubin, and J. L  v  que, "Comparison between inductive and resistive SFCL in terms of current limitation and power system transient stability," *Electr. Power Syst. Res.*, vol. 125, pp. 150–158, 2015.
- [20] H.-C. Seo, C.-H. Kim, S.-B. Rhee, J.-C. Kim, and O.-B. Hyun, "Superconducting Fault Current Limiter Application for Reduction of the Transformer Inrush Current: A Decision Scheme of the Optimal Insertion Resistance," *IEEE Trans. Appl. Supercond.*, vol. 20, no. 4, pp. 2255–2264, Aug. 2010.
- [21] Q. B. Dam and A. P. S. Meliopoulos, "Failure Probability Methodology for Overduty Circuit Breakers," in *2006 38th North American Power Symposium*, 2006, pp. 667–672.
- [22] Q. B. Dam and A. P. S. Meliopoulos, "Reliability implications of increased fault currents and breaker failures," in *2007 iREP Symposium - Bulk Power System Dynamics and Control - VII. Revitalizing Operational Reliability*, 2007, pp. 1–8.
- [23] Q. B. Dam, A. P. S. Meliopoulos, and G. J. Cokkinides, "A breaker-oriented fault analysis methodology," *Int. Trans. Electr. Energy Syst.*, vol. 23, no. 7, pp. 1071–1082, Oct. 2013.
- [24] M. R. Haghifam, A. Ghaderi, and M. Abapour, "Enhancement circuit breaker reliability by using fault current limiter," in *2009 IEEE Power & Energy Society General Meeting*, 2009, pp. 1–5.