

Kinematic Synthesis of a Novel Parallel Cable Robot as Artificial Leg

Ebrahim Shahabi

Department of Mechanical Engineering,
Sari Branch, Islamic Azad University, Sari, Iran.
E-mail: Ebrahim.shahabi.sh@gmail.com

MirAmin Hosseini*

Department of Mechanical Engineering,
University of Mazandaran, Iran.
E-mail: ma.hosseini@umz.ac.ir

*Corresponding author

Received: 24 February 2016, Revised: 12 April 2016, Accepted: 31 May 2016

Abstract: Accommodation of mechanism with human being's physical characteristics creates the possibility of safe and efficient interaction between human being and robot. Regarding the fact that amputation of a limb in human beings causes several mental, economical and social difficulties and problems, need to a substitute limb which has the most efficiency for the person after amputation is a vital need. The cable robots are the kinds of robots that the cable is used instead of rigid link. The cable robots have a simple appearance that some cables connect the motors to the final organ. In this research a robot with cable mover is designed and modeled as a tool in the case of creating movement with the most accordance for an artificial organ below the knee. In addition, in this mechanism some advantages are also considered including creating movement in two axes, its cheapness and lightness. In this research at first a primary design of the artificial organ is presented. The forward and inverse kinematic relations which are dominant on system are explained, in fact you can find different features with kinematic robots like dexterity, global condition, local condition, etc, and finally we study the available workspace for the system. Workspace in cable robots is different from other parallel robots, in this paper, first description about some methods for finding workspace in cable-driven-robots and then use of force-closure workspace to find workspace for this system are presented.

Keywords: Artificial organs, Cable robots, Forward and Inverse Kinematic, Neural Network

Reference: Shahabi, E., and Hosseini, M. A., "Kinematic Synthesis of a Novel Parallel Cable Robot as the Artificial Leg", Int J of Advanced Design and Manufacturing Technology, Vol. 9/No. 3, 2016, pp. 1-10.

Biographical notes: **E. Shahabi** received his MSc in Mechanical Engineering from University of Islamic Azad Sari Branch in 2015. His current research interest includes Robotic, Mechatronic and Manufacture. **M. A. Hosseini** is Assistant Professor of Mechanical Engineering at the University of Mazandaran, Iran. He educated in Mechanical Engineering at Tehran Polytechnic (Amirkabir University of Technology). He received his MSc and PhD from Tarbiat Modarres and Mazandaran University, respectively. His current research interest includes Parallel manipulator (Kinematic and Dynamic) and Parallel machine tools.

1 INTRODUCTION

Amputation means to lose a limb or member of body or a part of it that causes inability without exception and will have some economical, mental and social results and consequences. It is at the time that the number of amputation is increasing all over the world [1]. On the basis of recorded statistics live about 107 million peoples with amputation in the United States of America [2] and the number of these persons is increasing during the recent years [3]. It is estimated that one person per each 200 Americans encounters amputation during his lifetime [4]. In fact, more than 90 percent of amputation cases in these societies occur because of complications and effects of artery and heart disease. In the younger peoples the most reasons of amputation are Trauma and malignant [4]. Among other causes can name the frostbite, infections and nature defects of limbs [4], [5]. While in our country there is not any exact statistics from the number and reasons of amputation.

In the performed research at 1390 in Iran (in the form of retrospective and on all of the patients that were undergone the amputation surgery in Kerman instructional hospitals from 1380 till the end of 1388) the most rates of amputation were related to the limb under the knee [6]. With increasing development of science, the topic of artificial limbs and prosthetic science during recent years has increased so much, in such a manner that several of artificial limbs are created from union and combination of advanced robots and cybernetic systems which includes all the things which are controllable by the mind. For instance, we can point to the DEKA robotic arm [7], the first prosthetic arm that is supplied to the markets that does the complicated duties by recognizing the signals which are set from the muscles of patient. In the case of artificial limbs, the lower limbs particularly the limbs under the knee have significant developments during the recent years. Among these developments, the artificial leg that is created in MIT University [8] can be pointed. Also the most natural leg for disabled peoples is designed by Dr. Mohammad Rastegaar at 2013 in Michigan industrial University [9].

The cable robots are the kinds of robots that cables are used in them instead of rigid links. The cable robots have simple appearance that some cables link the motors to the end limb [10]. The cable robots have frequent uses; as an instance we can mention the cargo carrying cranes in the ports [11]. Also from the view point of workspace because of lack of limitation in choosing the cable length, these types of robots can be used in uses with very large workspaces such as filming or imaging from stadiums [12] or radio telescopes [13]. Very low mass of cable mechanisms attracts the researcher's attention to themselves in using these types of robots in space utilizations. The Charlotte's cable robot is one of the most popular and known tying cable mechanisms that is used to do the experiments in space-hub [14].

Another use of cable mechanisms is in the help and rescue operations because of natural disasters such as earthquake. In fact, again the characteristics of wide workspace and high

load carrying and transportation and fast installation of these robots attract the attention of researchers in the case of rescue and help operations [15]. Using high speeds in simulation systems and virtual reality causes usages of a part of cable parallel robots in development of this usage. The WARP (Wirepuller Arm Driven Redundant Parallel) mechanism is one of the mechanisms with 6 degrees of freedom with eight cable operator that is designed with emphasis on optimization of workspace [16]. Other mechanisms, such as Falcon [17] are also proposed with the aim of applying in very high speeds.

Regarding the safe and secure operation of cable, the probability of using this, is possible in rehabilitation systems and artificial limbs and members [18] to [20]. Recently, the element of cable is used in a group of parallel robots as a light replacement for the legs of robot [21]. In addition to the above mentioned cases, the robotic artificial hand is designed with ability of simulating the operation and work of hand fingers and creating the sense of touch in controlling the virtual reality by the help of cable motives and with light structures [22] to [24].

According to the performed researches about the use of cable robots' systems in rehabilitation tools and also replacing the lost limbs and body members, always it is tried to create and produce the limbs that have the most similarities with natural limbs in static and movement operations. Some of the challenges in this type of designing, are the uniformity in the joint movement, the mechanism of force transmission, similarity of the under studied mechanical system with the natural limb and organ, the nimbleness and quickness of the designed limb and member and creating torque in the joint.

In this research the purpose is the innovative designing of a robot that makes possible the movement of human's leg in two axes using the completely similar movement cable system. In the second part, according to the general structure of human's natural leg, it is tried to prepare a schematic design of the robot. In the third part the dominant relationships on the kinematic robot will be considered. At the end, the workspace of the above mentioned robot will be obtained regarding the extracted inverse kinematic equations.

2 GENERAL DESIGN OF ROBOT

2.1. The approach of generating the rotational movement in two axes

However, the artificial legs which are produced hitherto, have frequent complications from the viewpoint of designing and control, in such a manner that in some cases even control of the produced artificial limb was by the help of mind, but the problem of the leg's rotation in two axes had remained yet. This problem exist in conditions that the movement of natural leg in human beings is in two axes, that causes a smooth and simpler movement by the side of assurance from lack of probable falls and injuries for the person who has amputation. To perform this work, in this

research it is tried to use a universal limb and member in the ankle and create the movement of the end component or member of leg using the cable robots toward the movement of ankle in two axes.

2.2. Preliminary designing

To create the regarded mechanism and ankle movement in two axes, it is necessary to use the cable mechanism with two motors to supply the movement of the end member or limb and a universal member or limb to rotate in the ankle. The cables which are connected to the end limb or member are connected on a pulley that transfers the ability to pull the cable to the motor. The center of rotation in this system is coincided with the universal member or limb Fig. 1.



Fig. 1 Schematic figure of the designed artificial leg

3 KINEMATIC ROBOT

Kinematic studies the relations between the length of operators and executive position of robot in the space. According to the available data from each, the kinematic is divided into two inverses and forward kinematic. The forward kinematic determines the executor position according to the information related to the length of cables, while the inverse kinematic determines the length of cables regarding the position of robot executor. Analyzing the kinematic relationships have direct role in studying the workspace, nimbleness and quickness and other indicators in addition to designing the components.

3.1. Inverse Kinematic

The purpose of this part is to determine the length of cables in lieu of particular position of final executor. If we consider the vectors of position in the machines which are connected to the motor and mobile platform, according to Fig. 2 and Fig. 3, equation 1 is established for each of the related kinematic rings.

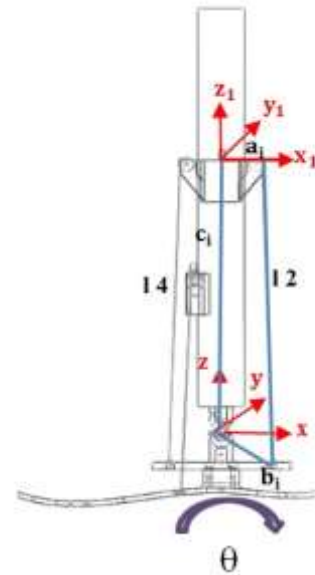

Fig. 2 Position vector of points in mechanism of cable robot from the side view

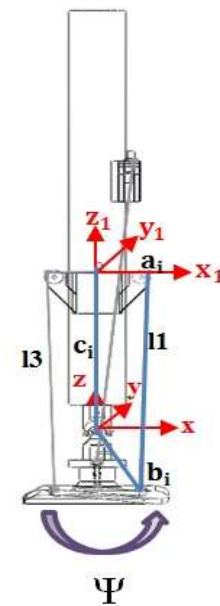

Fig. 3 Position vector of points in the mechanism of cable robot from the front view

$$Rbn_{bi} = ln_{li} - c_i + a_i \tag{1}$$

Where R is the Euler rotation matrix around the axes with the size of Ψ and θ , which is computable from the following equation.

$$R = \begin{bmatrix} C\theta & -S\theta & 0 \\ C\Psi S\theta & C\theta C\Psi & -S\Psi \\ S\theta S\Psi & C\theta S\Psi & C\Psi \end{bmatrix} \tag{2}$$

Where S and C indicate the Sin and Cos functions respectively. Also n_{li} , n_{bi} , a_i and c_i indicate the unit vectors which are related to the length of cables respectively, and vector a and b from i ring, a is to the distance between the motor and the connection point on pulleys and also c is related to the distance between motor and universal section. By performing the internal multiplication in two parts of equation 1 in n_{li} , will have:

$$l_i = Rbn_{bi}^T n_{li} + c_{nli}^T - a_{nli}^T \quad (3)$$

Finally solving the above equation I lieu for four cables, will result the length of operators.

3.2. Inverse Kinematic With Neural Network

The neural networks are one of the most widely used tools of artificial intelligence that robot angles are used as the input elements of network in them and the length of limbs or organs are considered as the network output in various conditions. Some of the works which are performed in this case consist of studying the inverse kinematic based neural networks [25], structure of modular neural networks to instruct the inverse kinematic model [26], comparing the inverse kinematic solution using the neural networks to control the robot 6 [27] and also comparing the RBF and MLP neural networks to solve the problem of inverse movement for robot R6 serial with combinational approach [28].

For this purpose, the MLP type neural network is designed and it is tried to calculate the inverse kinematic of the above mentioned design. The above neural network consists of 2 inputs which are the angles related to the final executor of robot and 4 outputs which are the cable lengths. In Fig. 4 a schematic of a neural network is shown.

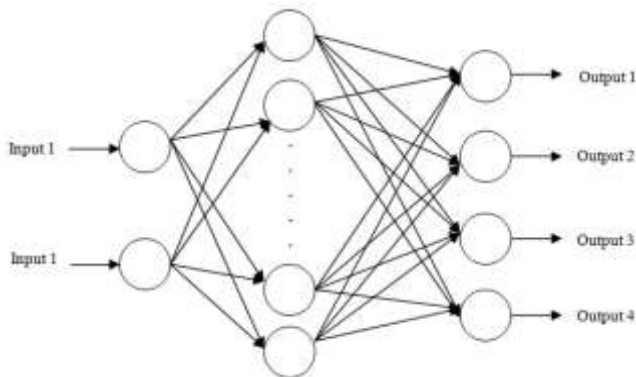

Fig. 4 Schematic of a neural network

In this research 150 data are used to instruct and also 10 series of data are used to test the network. The created network has a hidden layer that the mentioned layer has 14 neurons that are in the form of 2*14*4. According to Fig. 5 the instruction accuracy of the created network is about 93.242%. The output obtained from network instruction is also shown in Fig. 5 to Fig. 8.

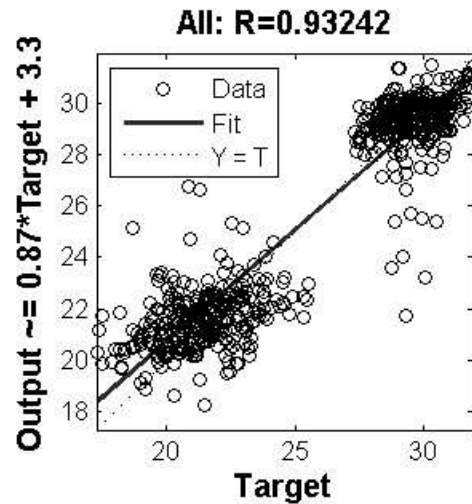

Fig. 5 Output of the network instruction percent

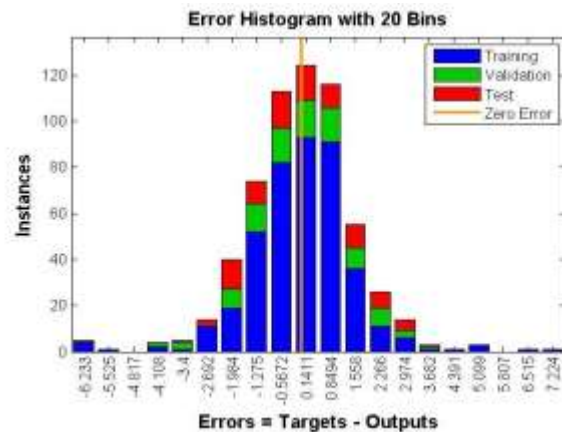

Fig. 6 Diagram of the network histogram error

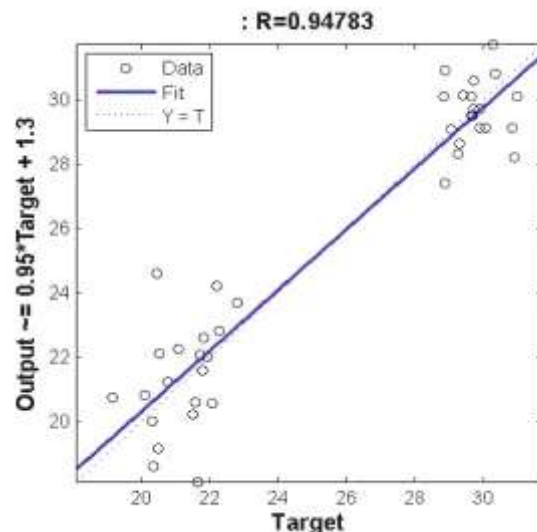

Fig. 7 Percent of the test data accuracy

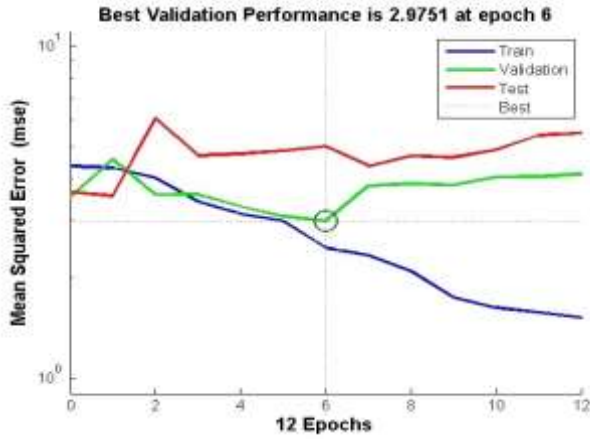

Fig. 8 Validation for the best operation of network

The numbers which are used to network instruction are shown in Table 1.

Table 1 The parameters which are used to network instruction

No.	Theta	Sai	Length of first cable	Length of second cable	Length of third cable	Length of forth cable
1	19.6	9.5	19.7	28.2	23.1	31
2	6.5	12.2	20.5	29.1	22.2	30.1
3	-19.9	-11	24.5	30.6	18.2	28.6
.
.
.
90	10.5	2	20.7	28.9	22.1	30.3
91	-1.8	-12	22.8	29.6	19.9	29.9
92	-9.3	13.4	23.6	30.1	19.2	29.1
.
.
.
148	-11	-4	23.1	30.2	19.7	29
149	4.4	0	21.3	29.3	21.4	29.9
150	0	15	21	29.5	21.8	29.7

3.3. Forward kinematic [29]

In this part the purpose is to determine the position, speed, and quickness of toes regarding the distinct vector of position, speed and quickness of cables. It is possible to rewrite the inverse kinematic relations in the form of equations 4 and 5, and the length of cables is shown by \mathbf{l}_1 in it.

$$l_1^2 = C^2\theta b^2_{1x} - 2C\theta b_{1x}S\theta b_{1y} - 2C\theta b_{1x}a_{1x} + S^2\theta b^2_{1y} + 2S\theta b_{1y}a_{1x} + a^2_{1x} + C^2\Psi S^2\theta b^2_{1x} + 2C^2\Psi S\theta b_{1x}C\theta b_{1y} + 2C\Psi S\theta b_{1x}c_1$$

$$+ C^2\Psi C^2\theta b^2_{1y} + 2C\Psi C\theta b_{1y}c_1 + S^2\Psi b^2_{1z} - 2S\Psi b_{1z}c_1 + c^2_1 + S^2\Psi S^2\theta b^2_{1x} + 2S^2\Psi S\theta b_{1x}C\theta b_{1y} + S^2\Psi C^2\theta b^2_{1y} + C^2\Psi b^2_{1z}$$

And

$$l^2_2 = C^2\theta b^2_{2x} - 2C\theta b_{2x}S\theta b_{2y} - 2C\theta b_{2x}a_{2x} + S^2\theta b^2_{2y} + 2S\theta b_{2y}a_{2x} + a^2_{2x} + C^2\Psi S^2\theta b^2_{2x} + 2C^2\Psi S\theta b_{2x}C\theta b_{2y} + 2C\Psi S\theta b_{2x}c_2 + C^2\Psi C^2\theta b^2_{2y} + 2C\Psi C\theta b_{2y}c_2 + S^2\Psi b^2_{2z} - 2S\Psi b_{2z}c_2 + c^2_2 + S^2\Psi S^2\theta b^2_{2x} + 2S^2\Psi S\theta b_{2x}C\theta b_{2y} + S^2\Psi C^2\theta b^2_{2y} + C^2\Psi b^2_{2z}$$

Now regarding change of the variable $t_2 = \tan(\frac{\Psi}{2})$, according to the following equations, for Sin (Ψ) and Cos (Ψ) we will have:

$$\sin\Psi = \frac{2t_2}{1+t_2^2}$$

$$\cos\Psi = \frac{1-t_2^2}{1+t_2^2}$$

So the equation 4 can be rewritten as the following:

$$M_1 t_2^2 + N_1 t_2 + L_1 = 0$$

That in it:

$$M_1 = b^2_{1x} + b^2_{1y} + b^2_{1z} + a^2_{1x} + c^2 + 2C\theta b_{1x}a_{1x} - 2S\theta b_{1y}a_{1x} + 2S\theta b_{1x}c + 2C\theta b_{1y}c$$

$$N_1 = -4S\Psi b_{1z}c$$

$$L_1 = b^2_{1x} + b^2_{1y} + b^2_{1z} + a^2_{1x} + c^2 - 2C\theta b_{1x}a_{1x} + 2S\theta b_{1y}a_{1x} + 2S\theta b_{1x}c + 2C\theta b_{1y}c$$

Thus for equation 5 we will have:

$$M_2 t_2^2 + N_2 t_2 + L_2 = 0$$

Where:

$$M_2 = b^2_{2x} + b^2_{2y} + b^2_{2z} + a^2_{2x} + c^2 + 2C\theta b_{2x}a_{2x} - 2S\theta b_{2y}a_{2x} + 2S\theta b_{2x}c + 2C\theta b_{2y}c$$

$$N_2 = -4S\Psi b_{2z}c$$

$$L_2 = b^2_{2x} + b^2_{2y} + b^2_{2z} + a^2_{2x} + c^2 - 2C\theta b_{2x}a_{2x} + 2S\theta b_{2y}a_{2x} + 2S\theta b_{2x}c + 2C\theta b_{2y}c \quad (15)$$

Now regarding change of the variable $t_1 = \tan\left(\frac{\theta}{2}\right)$, for $\sin(\theta)$ and $\cos(\theta)$ according to the following equations we will have:

$$\sin\theta = \frac{2t_1}{1+t_1^2} \quad (16)$$

$$\cos\theta = \frac{1-t_1^2}{1+t_1^2} \quad (17)$$

That consequently for available coefficients in equations 8 and 12 we will have:

$$M_1 = b^2_{1x} + b^2_{1y} + b^2_{1z} + a^2_{1x} + c^2 + \frac{2(1-t_1^2)b_{1x}a_{1x}}{1+t_1^2} - \frac{4t_1b_{1y}a_{1x}}{1+t_1^2} + \frac{4t_1b_{1x}c}{1+t_1^2} + \frac{2(1-t_1^2)b_{1y}c}{1+t_1^2} \quad (18)$$

$$N_1 = -\frac{8t_2b_{1z}c}{1+t_2^2} \quad (19)$$

$$L_1 = b^2_{1x} + b^2_{1y} + b^2_{1z} + a^2_{1x} + c^2 - \frac{2(1-t_1^2)b_{1x}a_{1x}}{1+t_1^2} + \frac{4t_1b_{1y}a_{1x}}{1+t_1^2} + \frac{4t_1b_{1x}c}{1+t_1^2} + \frac{2(1-t_1^2)b_{1y}c}{1+t_1^2} \quad (20)$$

$$M_2 = b^2_{2x} + b^2_{2y} + b^2_{2z} + a^2_{2x} + c^2 + \frac{2(1-t_1^2)b_{2x}a_{2x}}{1+t_1^2} - \frac{4t_1b_{2y}a_{2x}}{1+t_1^2} + \frac{4t_1b_{2x}c}{1+t_1^2} + \frac{2(1-t_1^2)b_{2y}c}{1+t_1^2} \quad (21)$$

$$N_2 = -\frac{8t_2b_{2z}c}{1+t_2^2} \quad (22)$$

$$L_2 = b^2_{2x} + b^2_{2y} + b^2_{2z} + a^2_{2x} + c^2 - \frac{2(1-t_1^2)b_{2x}a_{2x}}{1+t_1^2} + \frac{4t_1b_{2y}a_{2x}}{1+t_1^2} + \frac{4t_1b_{2x}c}{1+t_1^2} + \frac{2(1-t_1^2)b_{2y}c}{1+t_1^2} \quad (23)$$

According to the equations 8 and 12 and making linear equations we will have:

$$M_2(M_1t_2^2 + N_1t_2 + L_1) - M_1(M_2t_2^2 + N_2t_2 + L_2) = 0 \quad (24)$$

$$L_2(M_1t_2^2 + N_1t_2 + L_1) - L_1(M_2t_2^2 + N_2t_2 + L_2) = 0 \quad (25)$$

It's possible to show the above equation in the form of following matrix:

$$\begin{bmatrix} M_2N_1 - M_1N_2 & M_2L_1 - M_1L_2 \\ L_2M_1 - L_1M_2 & L_2N_1 - L_1N_2 \end{bmatrix} \begin{bmatrix} t_2 \\ 1 \end{bmatrix} = \begin{bmatrix} 0 \\ 0 \end{bmatrix} \quad (26)$$

To omit the t_2 parameter, the above equation can be rewritten as the following:

$$((M_2N_1 - M_1N_2)(M_2N_1 - M_1N_2) + (M_2L_1 - M_1L_2)^2) = 0 \quad (27)$$

So the obtained answer from equation 27 is the result of forward kinematic. It must be noted that the following relation is only calculated for one of the cables and to calculate the forward kinematic of the whole system, calculating the relations and equation for other cables in the same way are necessary.

4 LABORATORY SAMPLE

Regarding the operation of robot in the case of artificial limbs and members, the kinematic characteristics of artificial leg is considered in designing it. On the basis of existed and available bounds for ergonomics of leg and operation and work of human's leg, the regarding parameters are presented in Table 2.

Table 2 The geometric parameters of the prosthesis mechanism

Parameter name	Parameter amount
leg	0.45 (m)
Universal	0.07 (m)
Metatarsus	0.25 (m)
Ψ	-15~ 15 (deg)
Θ	-30 ~ 30 (deg)

On the basis of designed model, a laboratory model is made. In the above mentioned design, the required force to change the angle is supplied through a step motor. The cable that is connected to the shaft of step motor, after passing over the installed pulley next to the motor will be connected to the determined part on the leg. Two step motors with VEXTA model that is made in Japan with 5V voltage are used to rotate the leg Fig. 9.

As it is shown in Fig. 9 the controllable board of G is a connector or joiner between the artificial limb and computer to control the movement in the artificial limb or member. The part A is the universal that makes the limb or organ able to move in two axes. The used material in producing the leg that is shown by F is from polyethylene that in addition to appropriate rigidity has appropriate and enough resistance against thermal fluctuations too. The applied cables are silk cables that are observable with E in Fig. 9. The final executor in this limb or organ is made from Aluminum and is shown with D. As it is mentioned before, two motors, which are made by VEXTA Company, are used to move the final executor and are shown by B and also four pulleys which are made from Aluminum are used to guide and conduct the cables appropriately and are shown with C.

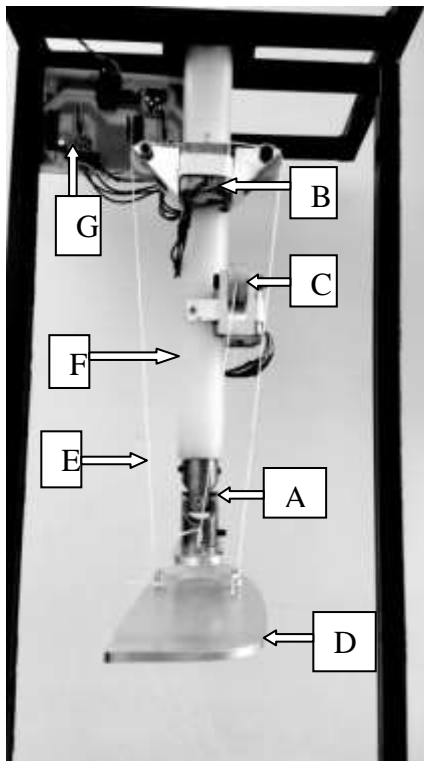

Fig. 9 Constituent components of the artificial limb or organ

Since the weight of produced sample connected to the part under the knee of the person who has amputation is important, it is tried to make the samples with minimum final weight, and the final weight for the discussed sample after installing the whole parts is 2.5 kg. After designing and producing the laboratory sample regarding the available parameters in Table 1, the operation of robot is examined and it is seen in Fig. 10 and Fig. 11.

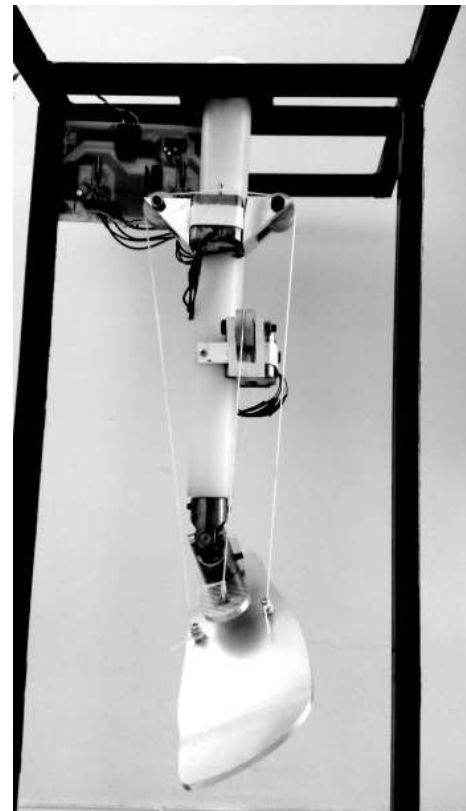

Fig. 11 Laboratory sample of artificial limb or organ after rotation

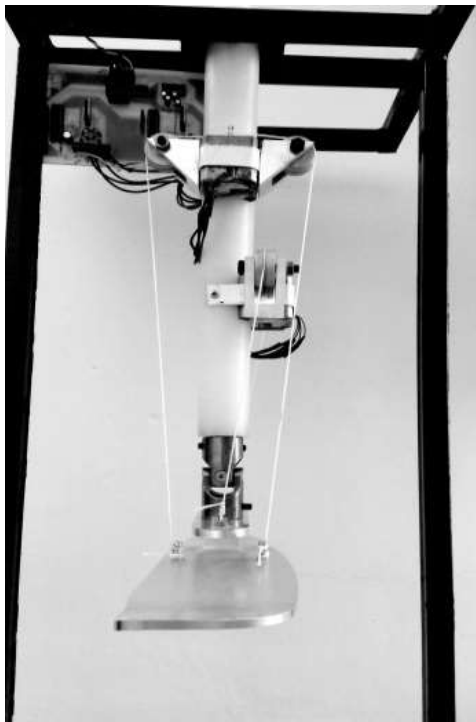

Fig. 10 Laboratory sample of artificial limb or organ before rotation

Also the amounts which are obtained from the inverse kinematic of robot with theoretical method and the measured amounts after rotation of final executor with experimental method in the made laboratory sample are shown in Table 3. From the viewpoint of comparing between the robot that is made in this article and the robot that is made in reference number 9, this is important that to perform the movement of final executor, in number 9 reference robot the synchronous operation of both motors which are used in the artificial limb is required, while in the robot that is made in this article this problem is solved, and this case leads to better control of robot and have access to more workspace.

Table 3 Comparing the theoretical and experimental results of inverse kinematic

Experimental results (cm)	Theoretical results (cm)	Selected angles (deg)
11=21,1 12=28,9 13=22	11=20,5909 12=29,2057 13=22,2095	$\theta = \delta, \psi = 1\delta$
14=20,5 11=21,5 12=29,1 13=21,7 14=20,2	11=21,2906 12=29,5466 13=21,5040 14=29,6554	$\theta = 30, \psi = -\delta$
11=22,7 12=29,8 13=20,2 14=29,4	11=22,6770 12=20,1665 13=20,2330 14=29,0335	$\theta = -10, \psi = \delta$
11=25,1 12=29,7 13=17,5 14=29,4	11=25,5334 12=29,9926 13=17,2666 14=29,2074	$\theta = -20, \psi = -1\delta$
11=22,2 12=20 13=20,5 14=29,2	11=22,6319 12=20,2631 13=20,1668 14=28,9369	$\theta = -12, \psi = \delta$
11=20,5 12=27,7 13=22,6 14=21,7	11=20,7531 12=27,9910 13=22,0469 14=21,2090	$\theta = 22, \psi = -\lambda$
11=18,9 12=27,1 13=24,1 14=22,4	11=19,0963 12=27,2222 13=23,7037 14=21,8768	$\theta = 20, \psi = 1\delta$
11=24,7 12=20,5 13=18 14=28,8	11=25,1884 12=20,8487 13=17,6116 14=28,3513	$\theta = -27, \psi = -9$
11=19,8 12=28 13=23 14=21,2	11=20,2316 12=28,6722 13=22,5684 14=20,7278	$\theta = 16, \psi = \delta$
11=20 12=28,5 13=22,9 14=20,7	11=20,3606 12=28,8989 13=22,6394 14=20,2013	$\theta = 10, \psi = 10$

5 WORKSPACE

Some researchers have said that the workplace of a cable robot is all of the places that final executor can have the static balance under the influence of gravity [30]-[33]. In several cases this definition is used to point to the workspace. In most of the cases the numerical solution and methods such as "Brute Force" method are used to find the workspace with static balance, that in this method whole of the space is fragmented and element and all the space is searched to find out that is this place an accessible place or not. There is an exception in reference [32] that analytical methods are used to find the boundaries of workspace for bound and non-bound platform robots. There is another

exception for reference [30] that in it the robot crane workspace boundaries are obtained with analytical method. One of the most common workspaces that are presented in cable mechanisms is the controllable workspace [34] that is known with the names of Wrench Closure workspace (WCW) [35] and Force Closure workspace (FCW) [36] too. In this workspace, the vectors of external force are the set of all of the force vectors in each direction and with each size. Also the bound of cable force vector is placed in the positive area of the real axis. An important point in this type of workspace is the necessity of cable redundancy condition in the mechanism and it can be studied in complete conditioned mechanisms [37]. In the above mentioned design, because this mechanism is conditioned completely, the Force Closure workspace is used to determine the available workspace in cable robot Fig. 12.

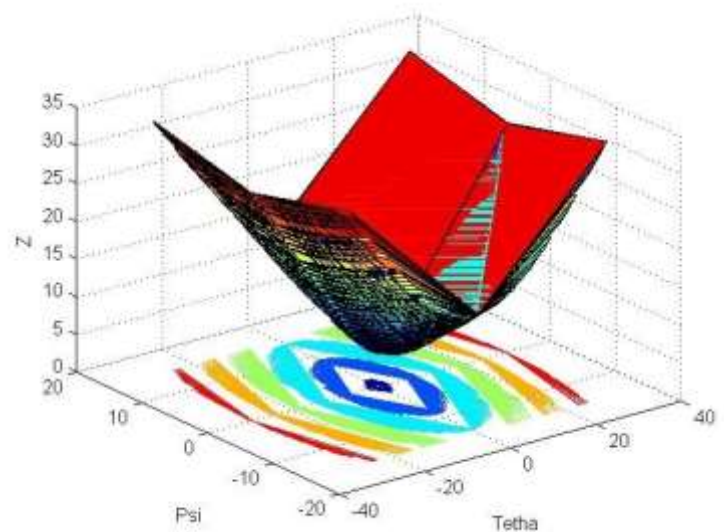
**Fig. 12** The obtained workspace according to the kinematic relations

Also the required explanations about the rotation obtained from natural ankle of human being are presented in appendix with schematic of its movements.

6 CONCLUSION

In the present study, it is tried to design a sample of artificial leg with ability to move in two axes with the help of cable robot, and this case is done with this structure for placement of motors for the first time. The equations which are related to the forward and inverse kinematic of model is solved, also the available workspace is also calculated for the designed model. An advantage of the above mentioned model is movement of the artificial leg in two axes which are similar to the movement of human's natural leg, also its lightness and low weight because of using cable robot and high flexibility are another advantages of the designed model.

7 APPENDIX

The movement of ankle is created because of muscular movements which are placed in the leg. These movements include:

- 1- Dorsiflexion: in this movement the leg moves toward the back or upward.
- 2- Plantar flexion: in this movement the leg moves toward the downward.
- 3- Eversion: in this movement the metatarsus is inclined to outward.
- 4- Inversion: in this movement the metatarsus is inclined to inward.
- 5- Abduction: in this movement the leg turns to the outside.
- 6- Adduction: in this movement the leg turns to the inside.
- 7- Supination: this movement is a combination of plantar flexion, inversion and adduction.
- 8- Pronation: this movement is a combination of dorsiflexion, abduction, and Eversion.

The schematic of movement number's 1 to 8 are shown in Fig. 12, Fig. 13 and Fig. 14.

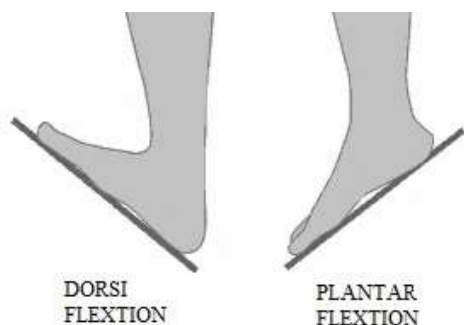

Fig. 13 Schematic of plantar flexion and dorsiflexion [38]

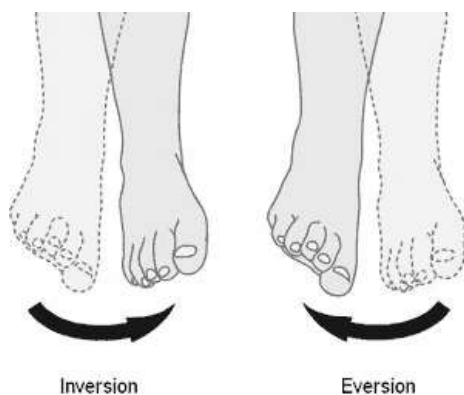

Fig. 14 Schematic of inversion and Eversion movement [39]

Ankle Rotation



Fig. 15 Schematic of rotational movement in the ankle [40]

REFERENCES

- [1] Kim, Y. C., Park, C. I., Kim, D. Y., Kim, T. S., Shin, J. C., "Statistical analysis of amputations and trends in Korea," *Prosthetics and Orthotics International*, Vol. 20, No. 2, 1996, pp. 88-95.
- [2] Graham, K. Z., Mackenzie, E. J., Ephraim, P. L., Trivison, T. G., Brookmeyer, R., "Estimating the prevalence of limb loss in the United States: 2005 to 2050," *Archives of Physical Medicine and Rehabilitation*, Vol. 89, No. 3, 2008, pp. 422-429.
- [3] Heck, J. R., "General principles of amputations," *Campbell's Operative Orthopedics*, Vol. 1, No. 11, 2008, pp. 561-578.
- [4] Adams, P. F., Hendershot, G. E., Marano, M. A., "Current estimates from the national health interview survey 1996," *National Center for Health Statistics*, No. 200, 1999.
- [5] Dillingham, T. R., Pezzin, L. E., Mackenzie, E. J., "Racial differences in the incidence of limb loss secondary to peripheral vascular disease: a population-based study," *Archives of Physical Medicine and Rehabilitation*, Vol. 83, No. 9, 2002, pp. 1252-1257.
- [6] Saied, A. R., Heidari, E., Shamsaldini, M., "Causes of amputations performed during a 9-Year period in hospitals affiliated to kerman," *Journal of Kerman University of Medical Sciences*, Vol. 19, No. 3, 2012, pp. 260-267. (In Persian)
- [7] Dario, F., Ning, J., Hubertus, R., Leš, H. A., Bernhard, G., Hans, D., Aszmann, C. O., "The extraction of neural information from the surface EMG for the control of upper-limb prostheses: Emerging avenues and challenges," *IEEE Transactions on Neural Systems and Rehabilitation Engineering*, Vol. 22, No. 4, 2014, pp.797-809.
- [8] Ernesto, C., Martinez, V., Jeff, W., Elliott, G., Herr, H., "Design of an agonist-antagonist active knee prosthesis," *Proceeding of the 2nd Biennial IEEE/RAS-EMBS International Conference on Biomedical Robotics and Biomechanics Scottsdale, AZ, USA, 2008.*
- [9] Ficanha, E. M., Rastgar, M., Mordian, B., Mahmoudian, N., "Ankle angles during step turn and straight walk: implications for the design of a steerable ankle-foot prosthetic robot," *Proceedings of the ASME 2013 Dynamic Systems and Control Conference*, October, 2013.
- [10] Saber, O., "A spatial translational cable robot," *Journal of Mechanisms and Robotics*, Vol. 7, No. 3, 2015.

- [11] Aghili, F., Buehler, M., Hollerbach, J. M., "Dynamics and control of direct-drive robots with positive joint torque feedback," *Proceeding of International Conference on Robotics and Automation*, Albuquerque, New Mexico, 1997, pp. 1156-1161.
- [12] Cone, L. L., "Skycam-an aerial robotic camera system," *Byte*, Vol. 10, No. 10, 1985, pp. 122-132.
- [13] Taghirad, H. D., Nahon, M., "Kinematic analysis of a macro-micro redundantly actuated parallel manipulator," *Advanced Robotics*, Vol. 22, No. 6, 2008, pp. 657-687.
- [14] Campbell, P. D., Swaim, P. L., Thompson, C. J., "Charlotte robot technology for space and terrestrial applications," In *SAE International Conference on Environmental Systems 25th*, San Diego, CA, 1995.
- [15] Merlet, J. P., Daney, R., "Modular parallel wire crane for rescue operations," *IEEE International Conference Robotics and Automation (ICRA)*, 2010, pp. 2834-2839.
- [16] Tadokoro, S., Murao, Y., Hiller, M., Murata, R., Kohkawa, H., Matsushima, T., "A motion base with 6-dof by parallel cable drive architecture," *Mechatronics on IEEE/ASME Transactions*, Vol. 7, No. 2, 2002, pp. 115-123.
- [17] Kawamura, S., Kino, H., Won, C., "High-speed manipulation by using parallel wire-driven robots," *Robotica*, Vol. 18, No. 1, 2000, pp. 13-21.
- [18] Taherifar, A., Salarieh, H., Alasty, A., "Minimum time and minimum switch path planning for a hyper-redundant manipulator with lockable joints," *Modares Mechanical Engineering*, Vol. 12, No. 1, 2012, pp. 50-65. (In Persian)
- [19] Brackbill, E., Mao, Y., Agrawal, S. K., "Dynamics and control of a 4-dof wearable cable-driven upper arm exoskeleton," *IEEE International Conference on Robotics and Automation*, Kobe International Conference Center Kobe, Japan, 2009, pp. 2300-2305.
- [20] Bamdad, M., Zarshenas, H., "Robotic rehabilitation with the elbow stiffness adjustability," *Modares Mechanical Engineering*, Vol. 14, No. 11, 2014, pp. 151-158. (In Persian)
- [21] Bamdad, M., "Cable-driven parallel robots: Time-energy optimal trajectory planning of cable-suspended manipulators," Springer Berlin Heidelberg, 2012, pp. 41-51.
- [22] Jacobsen, S. C., Iversen, E. K., Johnson, R. T., Knutti, D. F., Biggers, K. B., "The design of the Utah/MIT hand," *IEEE International Conference on Robotics and Automation*, Vol. 3, 1986, pp. 1520-1532.
- [23] Massie, T., Salisbury, J. K., "The PHANTOM haptic interface: A Device for Probing Virtual Objects," *Symposium on haptic interfaces for virtual environment and teleoperator systems*, Chicago, IL, Vol. 55, No. 1, 1994, pp. 295-300.
- [24] Saber, O., Abyaneh, S., Zohoor, H., "A cable-suspended robot with a novel cable based end effector," In *ASME 2010 10th Biennial Conference on Engineering Systems Design and Analysis*, 2010, pp. 799-808.
- [25] Köker, R., Cemil, Ö., Tarık, Ç., Hüseyin, E., "A study of neural network based inverse kinematics solution for a three-joint robot," *Robotics and Autonomous Systems*, Vol. 49, No. 3, 2004, pp. 227-234.
- [26] Oyama, E., Arvin, A., Karl, F. M., Taro, M., Susumu, T., "A modular neural network architecture for inverse kinematics model learning," *Neurocomputing*, Vol. 38, 2001, pp. 797-805.
- [27] Bingul, Z., Ertunc, H. M., Oysu, C., "Comparison of inverse kinematics solutions using neural network for 6R robot manipulator with offset," In *Computational Intelligence Methods and Applications*, 2005.
- [28] Chiddarwar, S. S., Ramesh, B. N., "Comparison of RBF and MLP neural networks to solve inverse kinematic problem for 6R serial robot by a fusion approach," *Engineering applications of artificial intelligence*, Vol. 23, No. 7, 2010, pp. 1083-1092.
- [29] Hosseini, M. A., Daniali, H. R. M., "Kinematic analysis of tricept parallel manipulator," *IJUM Engineering Journal*, Vol. 12, No. 5, 2012.
- [30] Gosselin, C. M., "Static balancing of spherical 3-DOF parallel mechanisms and manipulators," *The International Journal of Robotics Research*, Vol. 18, No. 8, 1999, pp. 819-829.
- [31] Ebert-Uphoff, I., Gosselin, C. M., Laliberte, T., "Static balancing of spatial parallel platform mechanisms-revisited," *Journal of Mechanical Design*, Vol. 122, No. 1, 2000, pp. 43-51.
- [32] Gallina, P., Rossi, A., Williams, I. I., Robert, L., "Planar cable-direct-driven robots," *Proceeding of the ASME IDETC/CIE Mechanics and Robotics Conference*, 2001, pp. 1241-1247.
- [33] Lee, M. K., Park, K. W., "Kinematic and dynamic analysis of a double parallel manipulator for enlarging workspace and avoiding singularities," *IEEE Transactions on Robotics and Automation*, Vol. 15, No. 6, 1999, pp. 1024-1034.
- [34] Verhoeven, R., "Analysis of the workspace of tendon-based Stewart Platforms," PhD Thesis, Duisburg-Essen University, 2004.
- [35] Gouttefarde, M., Merlet, J. P., Daney, D., "Determination of the wrench-closure workspace of 6-DOF parallel cable-driven mechanisms," Springer, 2006, pp. 315-22.
- [36] Lim, W. B., Yang, G., Yeo, S. H., Mustafa, S. K., "A generic force-closure analysis algorithm for cable-driven parallel manipulators," *Mechanism and Machine Theory*, Vol. 46, No. 9, 2011, pp. 1265-1275.
- [37] Kawamura, S., Ito, K., "A new type of master robot for teleoperation using a radial wire drive system," *IEEE/RSJ International Conference on Intelligent Robots and System, Intelligent Robots for Flexibility*, Vol. 1, No. 1, 1993, pp. 55-60.
- [38] Basic human anatomy, from https://www.dartmouth.edu/~humananatomy/figures/chapter_17/17-6.HTM
- [39] Foot fitness, from <http://fitsouffle.com/home?page=51>, accessed on 2013-05-23.
- [40] Active range of motion exercises, from <http://www.drugs.com/cg/active-range-of-motion-exercises.html>.