

A New Method for Channel Estimation in Orthogonal Frequency Division Multiplexing (OFDM) Systems Using Reduced Pilots

Maryam Imani, Hamidreza Bakhshi

Department of Electrical Engineering, Shahed University, Tehran, Iran.
Email: maryam_imani_30@yahoo.com

Received: July 2012

Revised: August 2013

Accepted: March 2014

ABSTRACT

In this paper, a new method for channel estimation is proposed based on a combination of pilots and pseudo pilots in OFDM system. In the suggested method, only half of the minimum necessary pilots that are required to obtain the minimum mean square error (MSE) of least square (LS) channel estimation is being used with the same efficiency of conventional methods.

KEYWORDS: Pilot, Pseudo Pilot, Channel Estimation, OFDM.

1. INTRODUCTION

An efficient technique for multicarrier modulation that has recently acquired much interesting in high data rate communication systems is Orthogonal Frequency Division Multiplexing (OFDM). One of the best advantages of OFDM is mitigation or elimination of intersymbol interference (ISI) in highly dispersive channels [1].

Accurate channel state information (CSI) in the receiver is a necessary for coherent detection in OFDM systems. Using transmission of pilot symbols for channel estimation provide the accurate and reliable CSI [2]. The estimation can be performed using least square (LS) [3] or linear minimum mean-square error (MMSE) [4].

Channel estimation using pilot symbols produces overhead that is inappropriate. Thus, keeping the number of pilot symbols as minimum as possible is an noteworthy goal. In [5], performances of two different channel interpolation methods to be used with OFDM systems are investigated. It has been demonstrated that the number of pilots can be decreased considerably by using piecewise-linear interpolation instead of piecewise-constant interpolation. In [6], a new and simple method is proposed to find the optimal number of pilot symbols for practical OFDM system. Analytical BER of Pilot symbol assisted modulation OFDM (PSAM-OFDM) in correlated or uncorrelated multipath fading is studied to search for the minimal number of pilot symbols. Optimal overhead in a packet based MIMO-OFDM system based on MMSE MIMO decoding analyzed in

[7]. Authors in [8], use methodology of compressed sensing (CS). CS makes it possible to exploit the delay-Doppler sparsely of wireless channels for reduction of number of pilots required for channel estimation within multicarrier systems such as OFDM. In proposed method of [9], transmitter sends fixed length of test signal to the channel. Then by using the response, number of pilot signals to insert is determined and correspondingly appended to the data signal, thus by varying the number of pilots depending upon the channel environment, it improves the channel estimation and reduces the number of pilots. In order to improve the weakness of high usage of pilots, it is proposed in [10] that the pilot insertion in the 1-D channel can be disposed in 2-D channel estimation.

Also channels which are not supported by pilots are estimated by the difference between the symbols which estimated from pilot and correlation factor in the time domain. In [11], the shortest preamble that attains a given mean square error in a sequence that under-sample the channel spectrum is found. In [12], authors propose a pseudo pilot algorithm for data detection in fast-varying channels without increasing the pilot density.

In this paper, we proposed a new method for channel estimation in OFDM systems and a combination of pilots and pseudo pilots have being used. The numbers of applied pilots are half of minimum of required pilots for obtaining the optimum efficiency in LS channel estimation. We propose two calculation methods for pseudo pilots.

This paper is involved with the following issue.

In section 2, description of OFDM system and LS channel estimation is given. The proposed algorithm is developed in section 3. Some simulations are given in section 4. Finally, section 5 concludes this paper.

Notations: $E\{\cdot\}$ will denote the statistical expectation; $(\cdot)^H$ will represent hermitian operator. The trace is denoted by $tr\{\cdot\}$ and I_N stands for the $N \times N$ identity matrix.

2. SYSTEM MODEL AND LS CHANNEL ESTIMATION

The OFDM system based on pilot channel estimation is given in figure 1. In the first step, the binary information is grouped and mapped according to the modulation in "signal mapper. After inserting the pilot symbols with a specific period or uniformly among data sequence, inverse discrete Fourier transform (IDFT) block is used to transform the data sequence of length N $\{X(k)\}$ into time domain signal $\{x(n)\}$ as follows:

$$\begin{aligned} x(n) &= IDFT\{X(k)\}, \quad n = 0, 1, \dots, N-1 \\ &= \sum_{k=0}^{N-1} X(k) e^{j(2\pi kn/N)} \end{aligned} \quad (1)$$

Where N denotes the IDFT length. After IDFT block, guard time, which is chosen to be larger than the expected delay spread, is inserted to prevent ISI. The result is an OFDM symbol given as follows:

$$x_f(n) = \begin{cases} x(n+N), & n = -N_g, -N_g+1, \dots, -1 \\ x(n), & n = 0, 1, \dots, N-1 \end{cases} \quad (2)$$

The length of guard interval is denoted by N_g . The transmitted signal $x_f(n)$ will pass through the multipath channel with each the real and imaginary part of each tap being an independent Gaussian random variable with mean 0 (Rayleigh multipath channel) with additive noise.

$$y_f(n) = x_f(n) \otimes h(n) + w(n) \quad (3)$$

Where $x(n)$ and $y(n)$ are transmitted and received signals respectively. $w(n)$ is additive white Gaussian noise AWGN noise and $h(n)$ is channel impulse response (CIR).

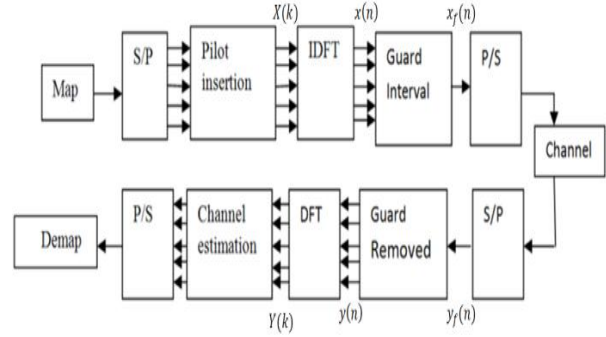

Fig. 1. OFDM system model

At the receiver, guard time is removed after passing to discrete domain through A/D and low pass filter:

$$y(n) = \begin{cases} y_f(n), & -N_g < n < N-1 \\ y_f(n+N_g), & n = 0, 1, \dots, N-1 \end{cases} \quad (4)$$

After that, $y(n)$ is sent to discrete Fourier transform (DFT) block for the following operation:

$$\begin{aligned} Y(k) &= DFT\{y(n)\}, \quad k = 0, 1, \dots, N-1 \\ &= \frac{1}{N} \sum_{n=0}^{N-1} y(n) e^{-j(2\pi kn/N)} \end{aligned} \quad (5)$$

Relation of channel response to received signal in frequency domain is represented by:

$$Y(k) = X(k)H(k) + W(k) \quad k = 0, 1, 2, \dots, N-1 \quad (6)$$

Where $Y(k)$, $X(k)$, $H(k)$ and $W(k)$ are received signal, transmitted signal, channel response and AWGN noise of k th subcarrier in frequency domain respectively. After that, channel is estimated. Then, transmitted data is estimated and binary information data is obtained back in "signal demapper" block.

The LS channel estimation is:

$$H_{LS} = X^{-1}Y \quad (7)$$

which minimizes $(Y - XFh)^H(Y - XFh)$
Where [13],

$$X = \text{diag}\{X(0), X(1), \dots, X(N-1)\}$$

$$Y = [Y(0)Y(1) \dots Y(N-1)]^T$$

$$W = [W(0)W(1) \dots W(N-1)]^T$$

$$Y = [H(0)H(1) \dots H(N-1)]^T = DFT_N\{h\}$$

$$F = \begin{bmatrix} W_N^{00} & \dots & W_N^{0(N-1)} \\ \vdots & \ddots & \vdots \\ W_N^{(N-1)0} & \dots & W_N^{(N-1)(N-1)} \end{bmatrix}$$

$$W_N^{nk} = \frac{1}{N} e^{-j2\pi(n/N)k} \tag{8}$$

3. PROPOSED ALGORITHM

In this section, we introduce our suggested algorithm for channel estimation. At first, for greater understanding of issue, we represent some definitions:

Pilot symbols: symbols whose values are correctly known.

Non-pilot symbols (data): symbols whose values are completely unknown.

Pseudo pilots symbols: symbols whose values are determined by an estimate method. They are non-pilot symbols before estimation was taking place and their values partially obtained after estimation.

The value for a pseudo pilot symbol can be either correct or wrong.

Proposed method: the pseudo pilot symbols together with the pilot symbols are used for channel estimation.

In [14] – [15], it has been shown that minimum number of necessary pilots for obtaining minimum MSE in LS channel estimation in a MIMO-OFDM system with N_t transmit antennas is equal to LN_t where L is the length of the longest CIR of the transmit-receive antenna pairs. In other words, if P denotes the number of necessary pilots, we have: $P \geq LN_t$.

Now, in a OFDM system with just one channel between receiver and transmitter ($N_t = 1$), minimum of P is L . We will only use $L/2$ pilots for channel estimation. Description of our algorithm is presented as follows: There are two types of blocks have been considered because the OFDM symbols can be treated as 2-D.

In the first type, block is composed of received symbols across frequency (sub-channels) at a fixed time slot, whereas for the second type, a block is composed of received symbols across time at a fixed frequency [12]. However, we consider a block of N_s symbols (type 1 or 2) as $y_0, y_1, \dots, y_{N_s-1}$ in each block. In conventional method, necessary pilots are uniformly located in block. But in the proposed method, we alternatively eliminate pilots and consider pseudo pilots instead of them. In other words, we use alternatively pilots and pseudo pilots. Thus, the number of used pilots will become half (see figure 2). These pilots are pseudo pilots that were determined after receiver estimation.

We state two methods for estimation of pseudo pilot values that represented as follows:

Method 1: the receiver observes all the possible pseudo pilots' patterns whose number is

$M^{N_{ps}}$, where N_{ps} denotes the number of pseudopilots within a block in a M -ary modulation. Recall that

pseudopilots are the same data symbols that receiver must estimate their value. PSV denotes the vector of pseudo pilot values. Receiver considers each possible PSV and combines it with original pilot symbols for channel estimation and data detection. For each PSV pattern that estimates the channel and consequently data's symbols, the receiver chooses the pattern of pseudo pilot. In other words, chosen PSV minimum a metric defined by:

$$c = \|r - s\| \tag{9}$$

Where r and s are received and transmitted data bits vectors that s is estimated by receiver respectively. This is clear that in this method, the efficiency of MSE does not change and just, the complexity of receiver increase.

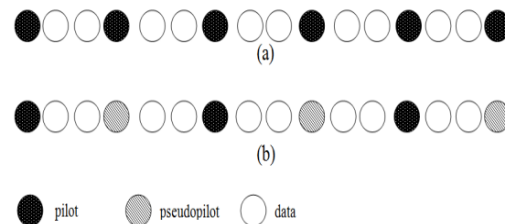

Fig. 2. Symbol components in a block
a) Conventional b) proposed

Method 2- receiver uses linear estimation for obtaining of pseudo pilot values. If R becomes the Observation vector and θ denotes unknown values vector, linear estimation of θ represented by:

$$\hat{\theta} = aR + b \tag{10}$$

Where a and b are constant vectors that can be found by minimizing the follow MSE cost function:

$$p = E \left[(\hat{\theta} - \theta)^2 \right] \tag{11}$$

Hencea, b can be determined by:

$$\frac{\partial p}{\partial a} = 0, \quad \frac{\partial p}{\partial b} = 0 \tag{12}$$

Then we will have:

$$a = \frac{\text{cov}(R, \theta)}{\text{var}(R)} \\ b = E(\theta) - aE(R) \tag{13}$$

In above equations, PSV and received signals of pseudo pilot positions in frequency domain are respectively located instead of θ and R . Estimation of

CIR in pilot and pseudopilot positions, according to LS estimation are respectively [16]:

$$\hat{h}_p = (x_p^H x_p)^{-1} x_p^H y_p$$

$$\hat{h}_{ps} = (\hat{x}_{ps}^H \hat{x}_{ps})^{-1} \hat{x}_{ps}^H y_{ps} \quad (14)$$

Where subscripts p and ps, denotes respectively pilot and pseudopilot positions. Also x and y represent transmitted and received signals. Note that $y = hx + n$, where h and n denotes respectively CIR and AWGN noise. \hat{x}_{ps} is linear estimation of transmitted pseudopilots (x_{ps}). Thus we have:

$$\hat{x}_{ps} = ay_{ps} + b \quad (15)$$

a and b are calculated according Eq. (13):

$$a = \frac{\text{cov}(y_{ps}, x_{ps})}{\text{var}(y_{ps})}$$

$$b = E(x_{ps}) - aE(y_{ps}) \quad (16)$$

MSE of channel estimation is defined as follows:

$$\text{MSE} = \frac{1}{L} E[\|h - \hat{h}\|^2]; \quad \hat{h} = \hat{h}_p + \hat{h}_{ps} \quad (17)$$

Thus, we have:

$$\text{MSE} = \frac{1}{L} E[\|h_p - \hat{h}_p\|^2] + \frac{1}{L} E[\|h_{ps} - \hat{h}_{ps}\|^2] + \frac{2}{L} E[\|h_p - \hat{h}_p\| \|h_{ps} - \hat{h}_{ps}\|] \quad (18)$$

We rewrite above equation as follows:

$$\text{MSE} = (\text{MSE})_p + (\text{MSE})_{ps} + \frac{2}{L} E[\|h_p - \hat{h}_p\| \|h_{ps} - \hat{h}_{ps}\|] \quad (19)$$

MSE in pilot positions is calculated as:

$$(\text{MSE})_p = \frac{1}{L} E[\|\tilde{n}\|^2] = \frac{1}{L} E[\text{tr}(\tilde{n} \tilde{n}^H)] \quad (20)$$

Where \tilde{n} is defined as:

$$\tilde{n} = (x_p^H x_p)^{-1} x_p^H n \quad (21)$$

MSE of the LS channel estimation in pilot positions is given by:

$$(\text{MSE})_p = \frac{\sigma^2}{L} \text{tr}[(x_p^H x_p)^{-1}] \quad (22)$$

In above equation, σ^2 is variance of noise. In order to obtain minimum of Eq. (22), we require $x_p^H x_p$ be diagonal matrix. In other words $x_p^H x_p = E I_L$ where E is energy of pilots? Thus we have:

$$(\text{MSE})_p = \frac{\sigma^2}{E} \quad (23)$$

MSE of the LS channel estimation in pseudo pilot positions is calculated as:

$$(\text{MSE})_{ps} = \frac{1}{L} E[\|h_{ps} - \hat{h}_{ps}\|^2] \quad (24)$$

Using Eq. (14), Eq. (15) and $y_{ps} = h_{ps} x_{ps} + n$, $(\text{MSE})_{ps}$ is calculated.

In this method, we only need the first and second order moments of received and transmitted signals. Receiver after determining of pseudo pilots values, combines them with original pilots and uses result set for channel estimation.

4. SIMULATION RESULTS

In this section, we evaluate proposed algorithm performance for channel estimation. OFDM system has 256 subcarriers and guard fraction is $\frac{1}{8}$. Length of channel is chosen 16 ($L = 16$). In usual manner for the propose of maximizing the bandwidth efficiency in LS channel estimation using uniform pilots, number of pilots is selected to L that is mentioned beforehand in [14] and [15]. Conventional method is shown at figure 2-a. In the proposed algorithm that is executed with two methods 1 and 2, we just use L/2 pilots for channel estimation. Figures 3-6 give a comparison of bit error rate (BER) performance between proposed channel estimation algorithm (that use two mentioned methods for obtaining of pseudopilot values) and conventional algorithm for BPSK modulation in Rayleigh multipath and Gaussian channels. It is necessary to say, method 1 has much complexity for high-order modulation. Figure 7 compares method 1 with method 2 in Rayleigh multipath channel. Our simulation represents that in a MIMO-OFDM system, using pseudo pilots plus pilots improve efficiency of channel estimation.

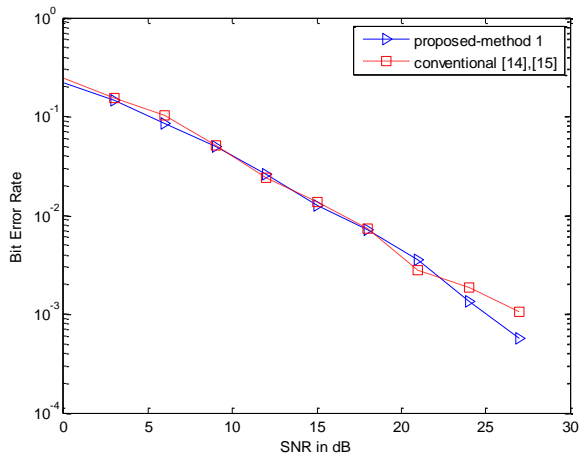

Fig. 3. BER comparison between proposed algorithm-method 1 and conventional method for channel estimation in Rayleigh multipath channel

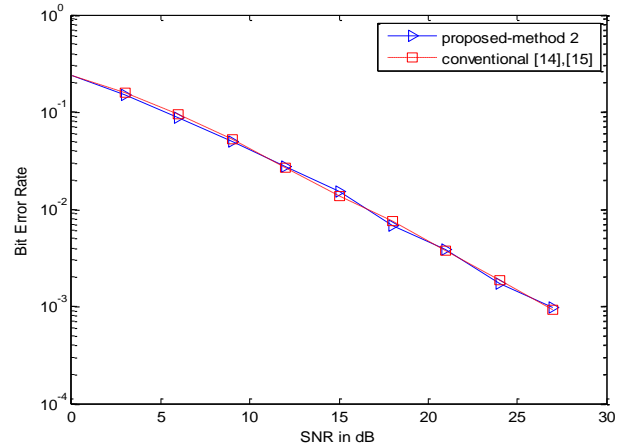

Fig. 6. BER comparison between proposed algorithm-method 2 and conventional method for channel estimation in Gaussian channel

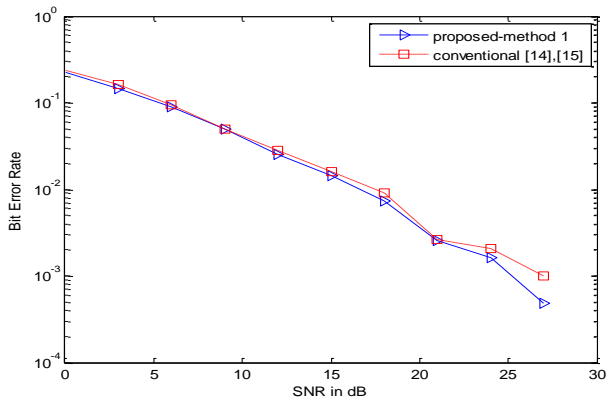

Fig. 4. BER comparison between proposed algorithm-method 1 and conventional method for channel estimation in Gaussian channel

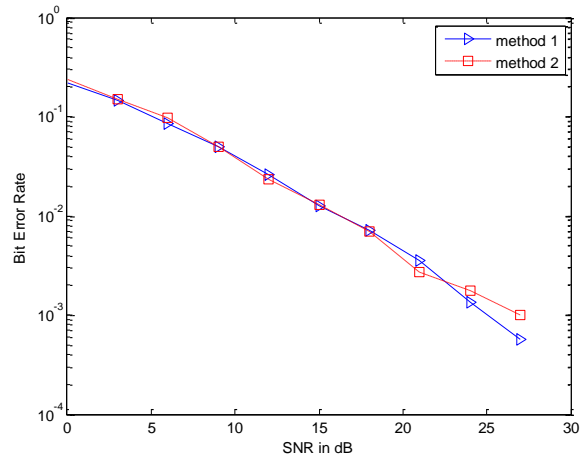

Fig. 7. BER comparison between proposed methods 1, 2 of proposed algorithm in Rayleigh multipath channel

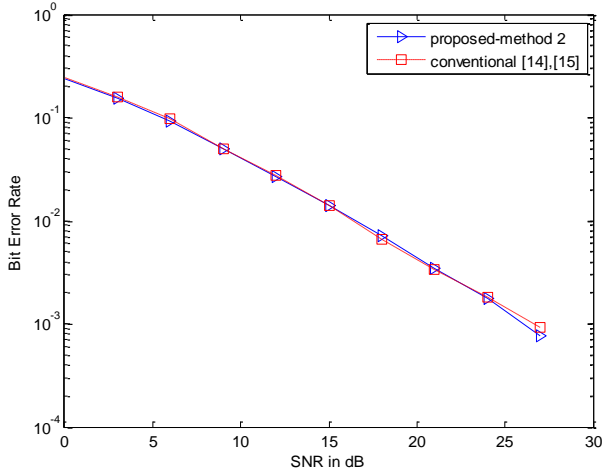

Fig. 5. BER comparison between proposed algorithm-method 2 and conventional method for channel estimation in Rayleigh multipath channel

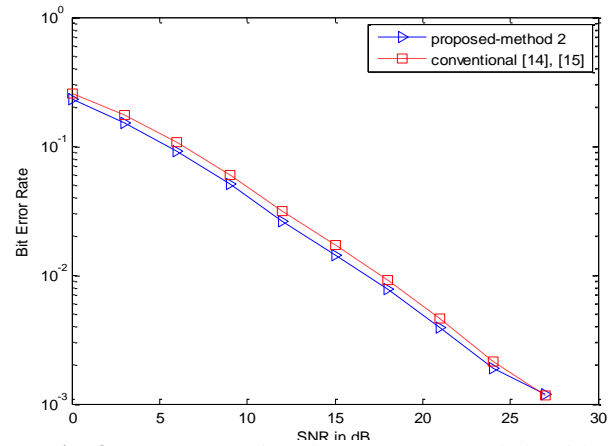

Fig. 8. BER comparison between proposed algorithm-method 2 and conventional method for channel estimation in Rayleigh multipath channel in MIMO-OFDM system

In other words, when there are several antennas in transmit and receive sides, with the same number of used pilots in conventional method, proposed method has better efficiency than conventional method. Figure 8 illustrates this subject. In this figure, we consider a 2×2 MIMO-OFDM system and $N_p L = 32$ pilots are used in the both algorithms of proposed and conventional channel estimation. Also, method 2 is used for obtaining the pseudo pilot values.

5. CONCLUSION

A new algorithm for channel estimation is proposed in this paper. Each OFDM block, only has half of the necessary pilots for obtaining minimum MSE in LS channel estimation. In fact, we use some pseudo pilots instead of eliminated pilots. Also we present two methods for determining of pseudo pilot values. Method 1 is useful for all order of modulation and has more complexity for high-order modulation than Method 2. Also we show in our simulation that using pseudo pilots plus pilots improve efficiency of channel estimation in a MIMO-OFDM system.

REFERENCES

- [1] J.G., Andrews, A., Ghosh and R., Mohammed "Fundamentals of WIMAX", chapter 4, Perentice Hall, 2007.
- [2] P., Fertl , G., Matz , "Channel Estimation in Wireless OFDM Systems With Irregular Pilot Distribution," *IEEE Trans. Signal Processing.*, Vol.58, No.6, pp. 3180-3194, June 2010.
- [3] J.J., Van de Beek , O., Edfors , M., Sandell , S.K., Wilson. And P.O., Borjesson , " On Channel Estimation in OFDM Systems," in *Proc. 45th IEEE VTC ' 95, Chicago, IL*, Vol.2, pp. 815-819, July 1995.
- [4] O., Edfors , M., Sandell , J.J., Van de Beek , S.K., Wilson and P.O., Borjesson., " OFDM Channel Estimation by Singular Value Decomposition," *IEEE Trans. Commun.*, Vol.46, No. 7, pp. 931-939, July 1998.
- [5] J., Rinne , M., Renfors , "Pilot Spacing in Orthogonal Frequency Division Multiplexing Systems on Practical Channels," *IEEE Trans. Consumer Electronics.*, Rosemont, IL, Vol.42, No.4, pp. 959-962, Nov. 1996.
- [6] W., Zhang , X-G., Xia.,P.C., Ching and W-K., Ma, "On The Number of Pilots for OFDM System in Multipath Fading Channels," *IEEE International Conf. on Acoustics, Speech, and Signal Processing, Proceedings, ICASSP '04*, Vol.4, pp. iv-381-iv-384, May 2004.
- [7] R., Mysore Rao , S., Lang and B., Daneshrad "Overhead Optimization in a MIMO-OFDM Testbed Based on MMSE MIMO Decoding," *60th IEEE VTC, Vehicular Technology Conf. on*, Vol.2, pp. 1468-1472, Sept. 2004.
- [8] G., Tauböck , F., Hlawatsch, "A Compressed Sensing Technique for OFDM Channel Estimation in Mobile Environments: Exploiting Channel Sparsity for Reducing Pilots," *IEEE International Conf. on Acoustics, Speech, and Signal Processing ,ICASSP, Las Vegas, NV*, pp. 2885-2888, March 31 2008-April 4 2008.
- [9] J., Byun , N.P., Natarajan , "Adaptive Pilot Utilization for OFDM Channel Estimation in a Time Varying Channel," *IEEE 10th Annual, Wireless and Microwave Technology Conf. on, WAMICON '09, Clearwater, FL*, pp. 1-5, April 2009.
- [10] S., Bae , Y., Jang , S., Shin , Z., Chengshi and K., Kwak " Two Dimentional Estimations With Reduced Pilot Arrangements for OFDM Systems," *Advanced Communication Technology International Conf. on, Phoenix Park*, Vol. 01, pp. 503-506, Feb. 2009.
- [11] C., Oberli , M., Constanza Estela and M., Ríos., " On Using Transmission Overhead Efficiently for Channel Estimation in OFDM," *IEEE Trans. Commun.*, Vol. 58, No. 2, pp. 399-404, Feb. 2010.
- [12] M., Chang , T.D., Hsieh., "Detection of OFDM Signals in Fast-Varying Channels With Low-Density Pilot Symbols," *IEEE Trans. Vehicular Technology*, Vol. 57, No. 2, pp. 859-872, March 2008.
- [13] S., Coleri.,M., Ergen , A., Puri and A., Bahai, " Channel Estimation Techniques Based on Pilot Arrangement in OFDM Systems " *IEEE Trans. Commun.*, Vol. 48, No.3 ,pp. 223-229, Sept. 2002.
- [14] H., Wang , J., Wang., "Optimal Pilot Design for MIMO-OFDM System Channel Estimation in Time Domain, " *3rd International Workshop on Signal Design and Its Applications in Communications, IWSDA*, Chengdu, pp. 307-312, Sept. 2007.
- [15] Q., Huang , M., Ghogho and S., Freear , " Pilot Design for MIMO OFDM Systems With Virtual Carriers, " *IEEE Trans. Signal Processing*, Vol.58, No.5, pp. 2024-2029, 2009.
- [16] H., Minn , D., Munoz., "Pilot Designs for Channel Estimation of MIMO OFDM Systems with Frequency-Dependent I/Q Imbalances," *IEEE Trans. Commun.*, Vol. 58, No. 8, pp. 2252-2264, August 2010.